



AUSTRALIAN  
**GLASS & WINDOW**  
ASSOCIATION

AUSTRALIAN GLASS AND WINDOW ASSOCIATION GUIDE SERIES

# A GUIDE TO GLASS AND GLAZING

## A HANDBOOK TO AS 1288



Thanks to our MAMA Supporters



# CONTENTS

<b>CONTENTS</b>	<b>ii</b>
<b>FOREWORD</b>	<b>iv</b>
<b>ACKNOWLEDGEMENTS</b>	<b>iv</b>
<b>ABOUT AGWA</b>	<b>v</b>
<b>DISCLAIMER</b>	<b>v</b>
<b>ABOUT GLASS</b>	<b>1</b>
<b>GLASS TYPES</b>	<b>3</b>
Float Glass	3
Tints and Tones	4
Decorative Glass	4
Low-E Glass	4
Insulating Glass Units	4
Safety Glass	5
Toughened Glass	6
Heat Strengthened Glass	7
Laminated Glass	7
<b>GLASS STANDARDS</b>	<b>8</b>
AS 1288 Glass in Buildings – Selection and Installation	8
AS/NZS 2208 Safety Glazing Materials in Buildings	8
AS/NZS 4666 Insulating Glass Units	8
AS/NZS 4667 Quality Requirements for Cut-To-Size and Processed Glass	8
AS/NZS 4668 Glossary of Terms Used in the Glass and Glazing Industry	8
<b>OTHER REGULATORY REQUIREMENTS</b>	<b>9</b>
The National Construction Code	9
AS/NZS 1170 Series Structural Design Actions	9
AS 4055 Wind Loads for Housing	9
AS 2047 Windows and External Glazed Doors in Buildings	9
AS 1926.1 Swimming Pool Safety Part 1 Safety Barriers for Swimming Pools	9
<b>DESIGN FOR WIND LOADS</b>	<b>11</b>
Regional Wind Speed	13
Terrain Category	13
Local Topography	13
Building Height, Shape and Orientation	14
The Effects of Shielding	14
Span of Glazing	14

<b>HUMAN IMPACT SAFETY</b>	<b>17</b>	<b>GLASS INSTALLATION</b>	<b>45</b>
Critical Locations	18	Safe Handling of Glass	45
Making Glass Visible	18	Preparation and Planning	46
Doors and Side Panels	19	Sealants	46
Glazing Capable of Being Mistaken for a Doorway or Opening	20	Dry Glazing	47
Low Level Glazing and Windows that are Full Height	20	Wet Glazing	49
Bathroom, Ensuite and Spa Room Glazing	20	Butt-Joint Glazing	49
Glazing in Stairways	20	Structural Silicone Glazing	50
Internal and External Shopfronts and Partitions	21	Setting Blocks	50
Schools, Early Childhood Centres, Aged Care Buildings and Nursing Homes	21	Laminated Glazing Materials	51
Insulating Glass Units	21	Insulating Glass Units	51
		Installation of Glass	51
<b>SLOPED OVERHEAD GLAZING</b>	<b>23</b>	<b>GLASS CUTTING AND PROCESSING</b>	<b>53</b>
<b>GLAZING FOR BALUSTRADES AND POOL FENCING</b>	<b>25</b>	<b>DEFECTS IN GLASS</b>	<b>58</b>
Balustrades	25	Feathering	58
Swimming Pool Fences	25	Shells	58
		Scratches	58
<b>FRAMED, UNFRAMED AND PARTLY FRAMED GLASS ASSEMBLIES</b>	<b>27</b>	Starts and Runs	58
<b>SHOWER SCREENS</b>	<b>29</b>	<b>NICKEL SULPHIDE AND HEAT SOAKING OF TOUGHENED GLASS</b>	<b>59</b>
<b>ENERGY EFFICIENT GLAZING</b>	<b>31</b>	<b>THERMAL STRESS GLASS BREAKAGE</b>	<b>60</b>
About Energy Efficiency	31	Risk Factors	60
Energy Efficient Glazing Assessment	32	<b>CARE AND MAINTENANCE OF GLASS</b>	<b>61</b>
U-Value	32	On-Site Protection	61
Solar Heat Gain Coefficient	32	Cleaning	61
Visible Transmittance	32	Notes	61
Energy Efficiency of Glass	32	<b>APPENDIX A: GLASS THICKNESS GUIDE TABLES FOR WIND CLASSIFICATIONS ONLY</b>	<b>63</b>
Energy Efficiency of Window Systems	32	<b>APPENDIX B: REFERENCED DOCUMENTS</b>	<b>79</b>
Regulatory Requirements	33	<b>APPENDIX C: GLOSSARY OF TERMS</b>	<b>80</b>
A Guide to Selection	33	<b>LIST OF IMAGES AND TABLES</b>	<b>88</b>
Condensation on Glazing	34		
<b>ACOUSTIC GLAZING FOR NOISE ATTENUATION</b>	<b>37</b>		
Measurement of Sound	37		
Regulatory Requirements	38		
Acoustic Performance of Glass	38		
High Performance Solutions	39		
Noise Reduction by Glass Type	39		
<b>GLAZING IN BUSHFIRE PRONE AREAS</b>	<b>41</b>		
BAL Testing	42		

# FOREWORD

This handbook has been written to provide guidance for architects, building designers, engineers, fabricators, glaziers and associated industry professionals on the proper use and application of glass in the building and construction industry.

Glass is one of the most practical, versatile and interesting building products. Despite its transparent nature, glazing, when used to its full potential, is often the most extraordinary architectural feature of a building. It can add interesting and unique elements to any building - adding character and improving the form and function of a space. Glazing also provides significant benefits to building occupants through the use of natural light, creating a feeling of openness and providing expansive views of the outside world.

Glazing has a major impact on energy consumption. If applied improperly, it can be a significant source of heat gain and loss. However, when selected carefully, glass can be used in such a way as to dramatically enhance a building's energy efficiency.

In today's built environment, glazing does far more than keep out the wind and rain (although these have always been its primary function). It has become increasingly important to consider the design, selection and installation of glazed elements. Performance characteristics such as safety, energy efficiency, acoustic attenuation and fire protection are but a few of the functions a well-considered glazing system can achieve.

To this end, advances in technology have made available a host of new and exciting glazing products; high performance double and triple glazing systems, spectrally selective films and Low-E coatings, and specially developed acoustic laminates to name a few.

While this handbook includes references to a number of Australian Standards and the National Construction Code, it is not, nor is it intended to be, a definitive prescription of the regulatory framework. This handbook provides guidance for the most common applications of glass and glazing and serves as an overview of current industry practice. The correct and proper assessment of glazing requirements requires a thorough understanding and application of the relevant provisions.

# ACKNOWLEDGEMENTS

The Australian Glass and Window Association (AGWA) would like to acknowledge the contribution of the following in the preparation of this guide:

- AGWA Technical Committee
- Australian Fenestration Training Institute (AFTI)

Special thanks to:

- Australian Glass Group
- DLG Aluminium & Glazing
- G.James
- Overseas Glass Agencies
- SCM Group Australia
- Viridian

# ABOUT AGWA

The AGWA is made up of over 1100 Glass Processors, Glaziers, Window Manufacturers and Industry Suppliers throughout Australia and overseas. Members of the Association have products tested to Australian Standard AS 2047 and glaze products in accordance with AS 1288. When purchasing from an AGWA member, buyers can be confident that the products are made to withstand Australian conditions. Non-compliant products may not be suited to Australian conditions.

The aims of the AGWA are:

- To promote and advance the awareness of glass and windows as a major architectural component in building design.
- To establish and self-regulate minimum benchmark standards throughout Australia. To facilitate the education and marketing of these standards throughout the industry and wider community.
- To provide a national voice when representing the industry in discussion and negotiations with government, local authorities, business and trade associations and organisations, and the private sector.
- To promote and encourage ethical conduct and sound business practice in the industry.

The Window Energy Rating Scheme (WERS) is owned and operated by the AGWA and provides a scientifically based, fair and credible rating system for the assessment of fenestration products for their energy efficiency performance. WERS is accredited by the Australian Fenestration Rating Council (AFRC) and adheres to AFRC protocols and procedures for the rating of windows and glazed doors. Energy Ratings provided by WERS are third party certified to the AFRC requirements, compliant with the National Construction Code (NCC), and able to be used to meet regulatory requirements.

# DISCLAIMER

This guide has been developed to provide general guidance, awareness and education to AGWA members, stakeholder groups and consumers. It should not be viewed as a definitive guide. While every effort has been made to ensure the information is accurate, the AGWA expressly disclaims all and any liability to any person for anything done in reliance on this publication. No responsibility is accepted by the AGWA for any mistakes, errors or omissions in this publication.



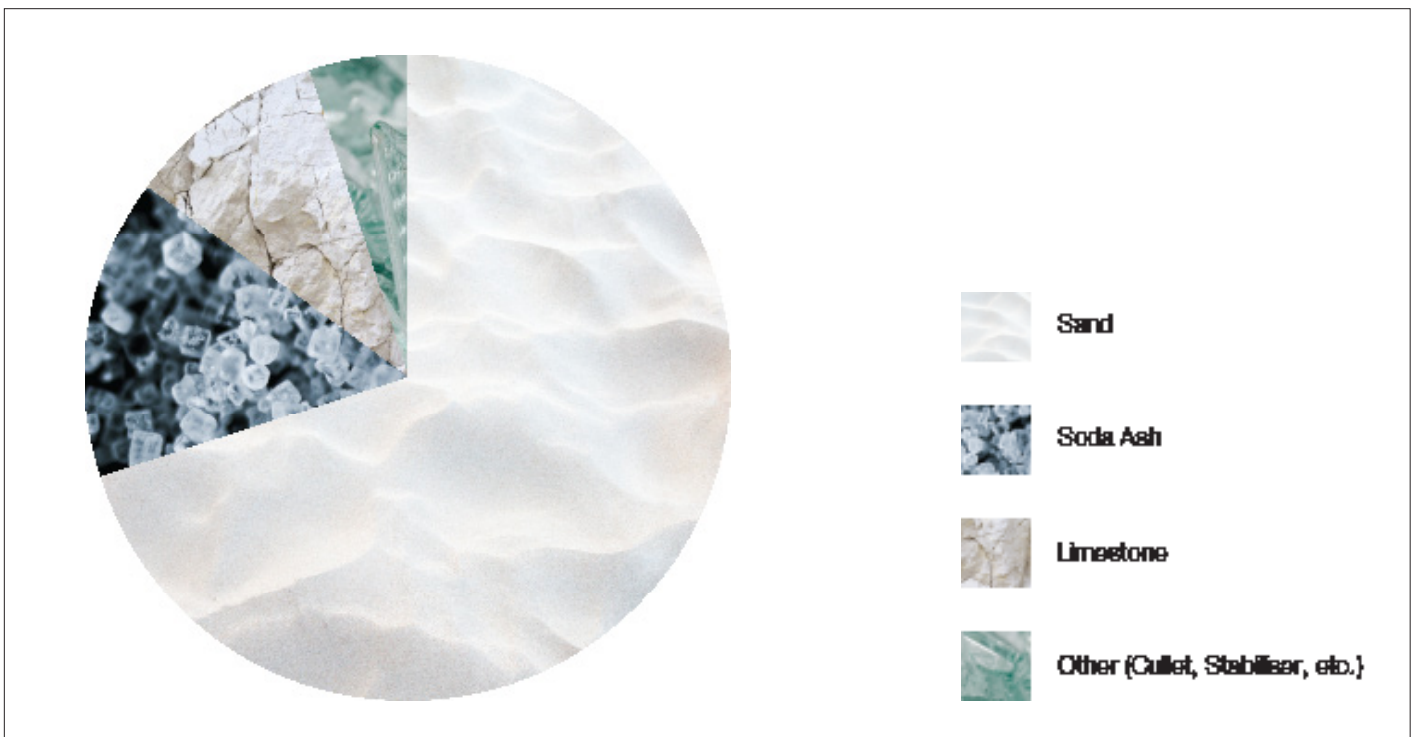
# ABOUT GLASS

Glass is made by melting together several minerals at very high temperatures. Silica, in the form of sand, is the main ingredient and is combined with other substances to form a 'batch' and melted in a furnace at temperatures of 1500 °C.

The basic raw materials include:

- Former: Silica (quartz sand).
- Fluxing agent: Lime and soda ash (sodium carbonate).
- Stabiliser: Calcium oxide (CaO), magnesium oxide (MgO), alumina, etc.
- Cullet: Broken glass is also used in the batch to speed up the melting process.
- Other materials that are added to produce different colours or properties as required.

Figure 1 Glass Composition







# GLASS TYPES

## FLOAT GLASS

In the batch process, the raw materials are mixed, then fed together with suitable cullet in a controlled ratio, into a furnace where it is heated to approximately 1500 °C.

The principal reactions between the raw materials take place within the melting zone, which occupies about a third of the tank. The melting process is crucial to glass quality. Once molten, the glass then flows in a continuous ribbon from the glass furnace onto a bath of molten tin.

The glass, which is highly viscous, floats on top of the flat surface of the tin to form perfectly smooth surfaces on both the top and bottom with uniform thickness. This is where the name 'float' glass comes from.

As the glass flows along the tin bath, the temperature is gradually reduced until the sheet is sufficiently solidified and can be transferred (at a controlled speed) from the tin onto rollers. Variation in the flow speed and roller speed enables the formation of glass sheets of different thicknesses.

Once off the bath, the glass sheet passes through an annealing chamber called a Lehr where it is cooled gradually to avoid strain and cracking from the temperature change. On exiting, the glass is inspected for defects and then cut to size.

The entire process operates continuously for the duration of the 'campaign' which, for most plants, will be roughly 12 to 15 years. A float line can be nearly half a kilometre long and will produce around 6,000 kilometres of glass annually, in thicknesses between 0.4 mm and 25 mm and in widths up to three metres.

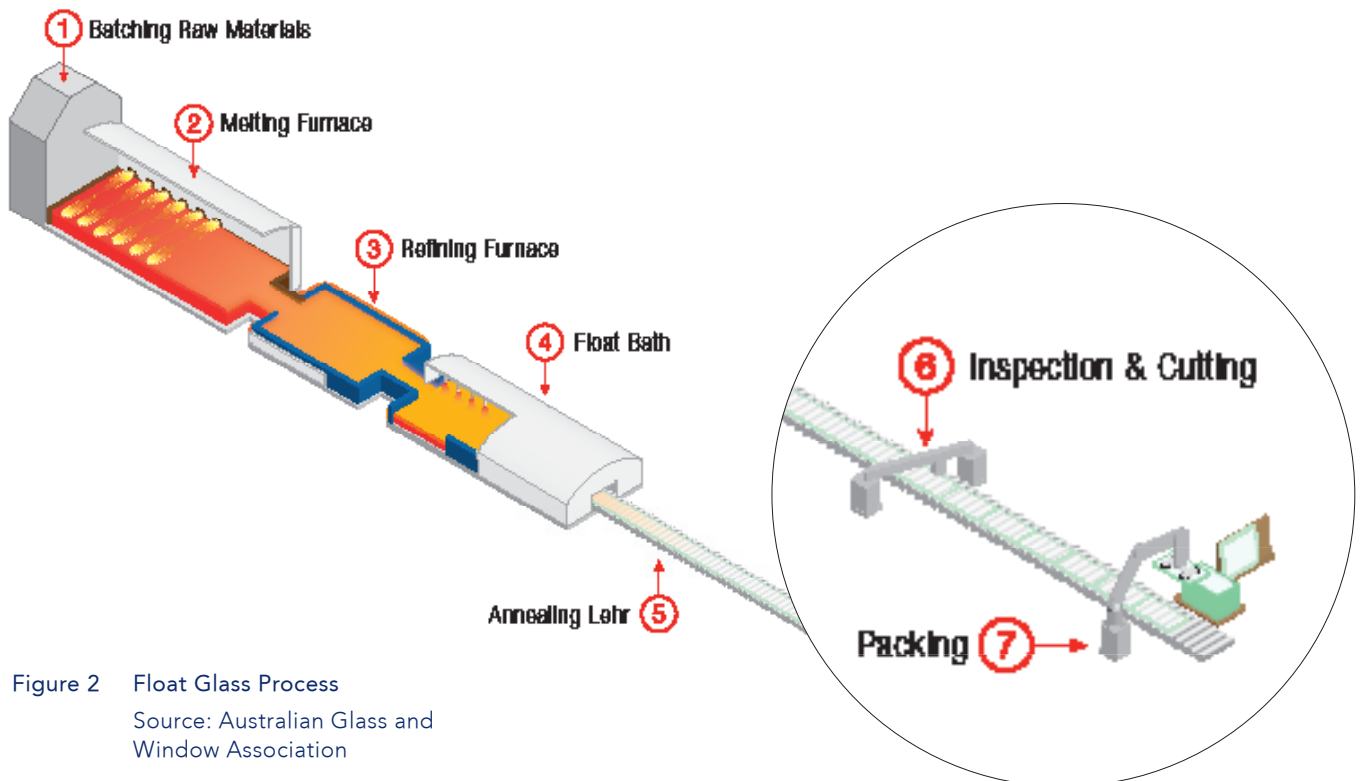


Figure 2 Float Glass Process  
Source: Australian Glass and Window Association

## TINTS AND TONES

During the batching process, additional materials may be added to alter the properties of the float glass. Tinted glass is produced by the addition of small amounts of metal oxides and is commonly produced in bronze, green, blue or grey. The addition of the tint does not affect the basic properties of the glass except for lowering the amount of visible light and solar energy transmittance.

## DECORATIVE GLASS

Decorative glass comes in many forms and has many uses. It may be patterned, etched, coloured or formed (slumped). Most commonly, decorative glass is used to enhance privacy by making the glass obscure or translucent for bathrooms, ensuites, front entries and the like. Coloured glass is common in leadlights and heritage windows. Printed glass has an image printed onto one side of the glass and is commonly used in foyers of commercial buildings and for kitchen splashbacks. There are literally thousands of decorative glass options.

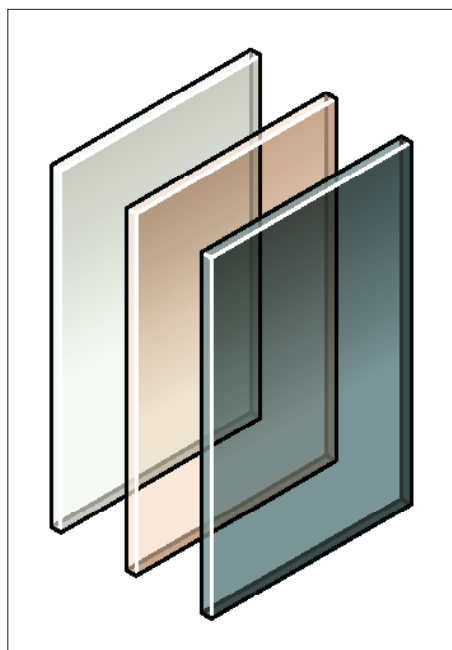


Figure 3 A Range of Glass Tints and Tones  
Source: Shutterstock

## LOW-E GLASS

Low-E stands for low emissivity glass. It is manufactured by the addition of a special thin metal coating on one side of the glass. Low-E glass increases the energy efficiency of windows by reducing the transfer of heat or cold through the glass. This means that in winter, a house stays warmer, and in summer, it stays cooler. There are two types of Low-E glass available; hard coat (pyrolytic) and soft coat (sputtered).

Hard coat, often referred to as pyrolytic Low-E coating, is bonded to the glass while it is in a semi-molten state. The process by which the coating is applied to the glass is called chemical vapour deposition. The result is a baked-on surface layer that is quite hard and thus very durable - which is why pyrolytic Low-E is sometimes referred to as 'hard-coat Low-E'.

A pyrolytic coating can be ten to twenty times thicker than a sputtered coating but is still extremely thin. Pyrolytic coatings can be exposed to air and cleaned with traditional glass cleaning products and techniques without damaging the coating.

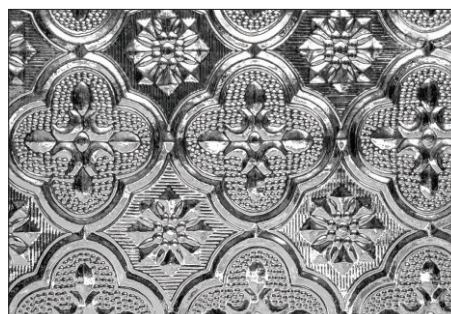
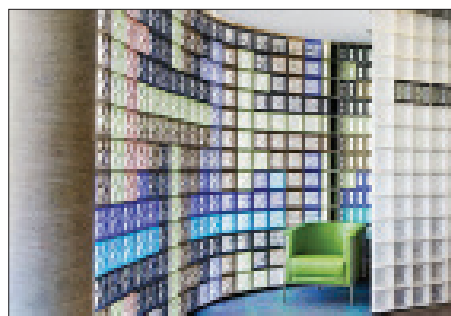


Figure 4 A Selection of Decorative Glass Types  
Source: Glass Block Constructions (top), Shutterstock (bottom)

Sputtered coatings are multilayered coatings that are typically comprised of metals, metal oxides and metal nitrides. These materials are deposited on glass or plastic film in a vacuum chamber. Although these coatings range from three to possibly more than thirteen layers, the total thickness of a sputtered coating is only one ten thousandth the thickness of a human hair.

Sputtered coatings often use one or more layers of silver to achieve their heat reflecting properties. Since silver is an inherently soft material that is susceptible to corrosion, the silver layer(s) must be surrounded by other materials that act as a barrier to minimise the effects of humidity and physical contact.

Historically, sputtered coatings were described as 'soft-coat Low-E' because they offered little resistance to chemical or mechanical attack. Most sputtered coatings are not sufficiently durable to be used in single glazed applications. However, when the coated surface is positioned facing the air space of a sealed insulating glass unit, the coating should last as long as the sealed glass unit.

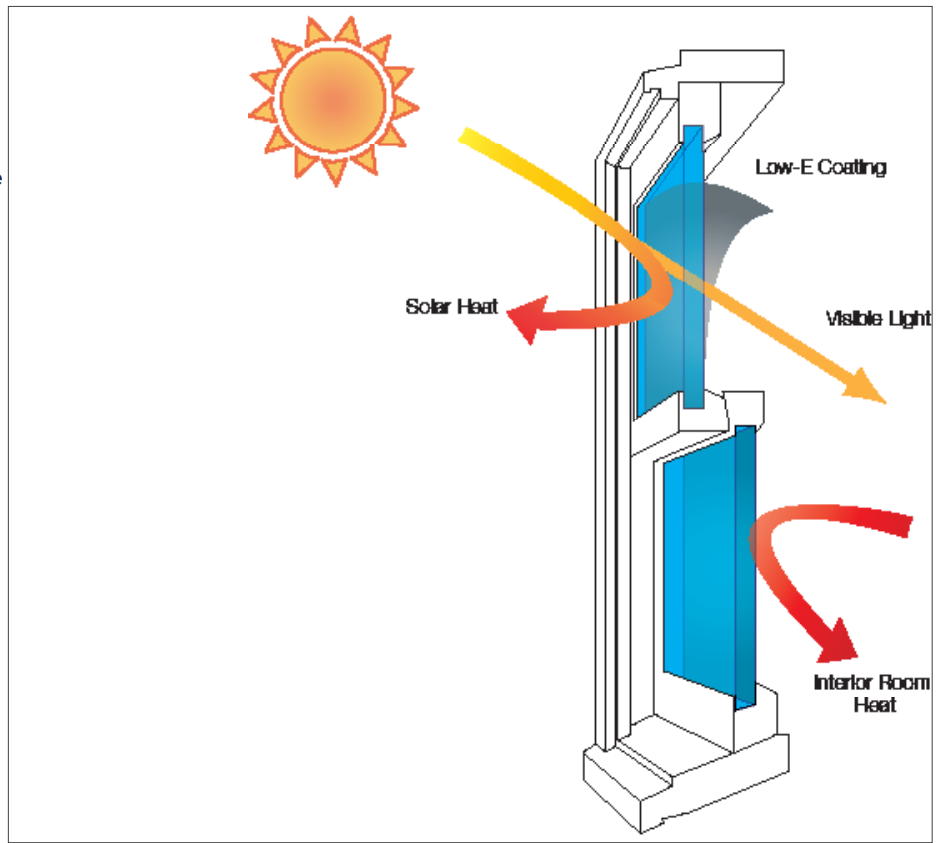
## INSULATING GLASS UNITS

One of the shortcomings of glass is its relatively poor insulating qualities. Multiple panes of glass with air spaces in between improve the insulating value considerably.

An Insulating Glass Unit (IGU) consists of two or more glass panes separated by a spacer and sealed to prevent humid outside air from entering the unit. Typically, spacers are filled with or contain a desiccant to remove moisture trapped in the gas space during manufacturing to prevent condensation forming.

Double glazing (two panes of glass) is the most common form of IGU and can reduce heat loss (or gain) by more than 50 per cent in comparison to single glazing - although visible light transmittance and solar heat gain for a double-glazed unit with clear glass will remain relatively high. Adding a Low-E coating to a surface of the double-glazed unit will increase the energy

**Figure 5 Low-E Glazing**  
An example illustrating the types of radiation that Low-E coating deflects, enabling greater energy efficiency of the window system.  
Source: Australian Glass and Window Association



performance as will adding a gas fill between the layers of glass.

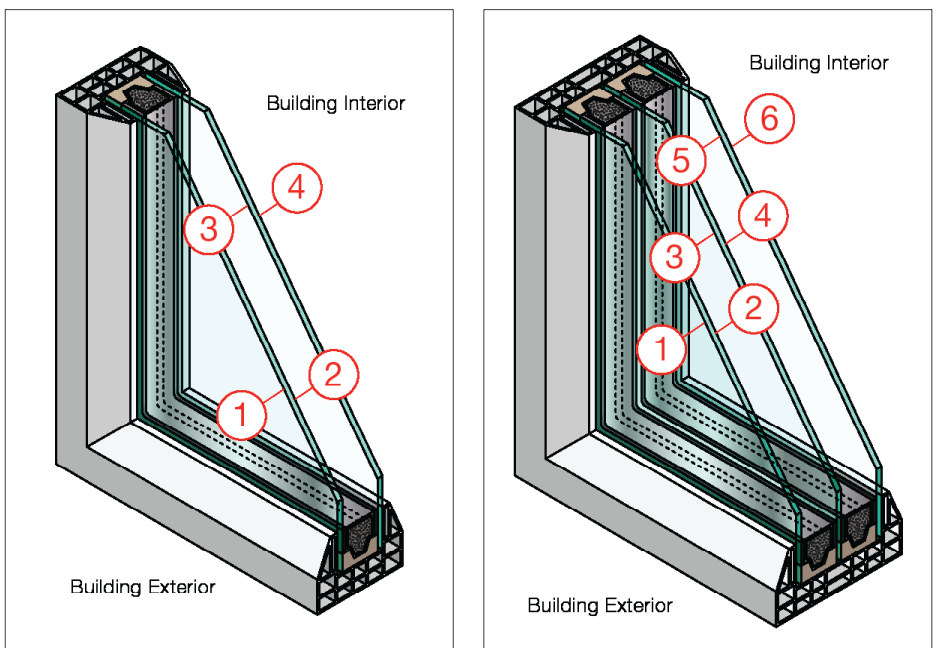
Double glazing often incorporates special coatings. In order to identify specific surfaces a numbering system is used. The exterior surface is numbered 1 and each glass surface is then numbered up to the interior surface. The same numbering system is also used for laminates. Refer to Figure 6 for the illustrations of surface numbering.

**SAFETY GLASS**

Ordinary glass when broken can form large, sharp, dangerous shards. Safety glass incorporates additional features that make it less likely to break or less likely to pose a threat when broken.

Common types of safety glass include toughened glass (also known as tempered glass), laminated glass, wire mesh glass (also known as wired glass) and vinyl backed safety mirror. Although safety glazing materials may break under sufficient impact, their fracture characteristics are such that if broken, the likelihood of injuries will be minimised.

AS 1288 Glass in Buildings requires the use of safety glass when glazing is situated where accidental breakage due to human impact is reasonably foreseeable. All safety glass used in Australia must be compliant to AS/ NZS 2208 Safety Glazing Materials in Buildings which sets out the test



**Figure 6 Insulating Glass Units**  
Examples of Double Glazed and Triple Glazed Units, illustrating surface numbering.  
Source: Shutterstock

requirements and procedures for testing glazing material safety after breakage. There are two categories of safety glass specified in AS/NZS 2208, Grade A and Grade B, with Grade A having the higher performance level. The test requirements for the different glazing materials are designed to promote safety and to reduce or minimise the likelihood of cutting and piercing injuries from human impact.

Compliant glazing materials must be legibly and permanently marked with a stamp or sticker with the following information:

- (a) The name or registered trademark of the manufacturer or supplier.
- (b) The number of the Australian/New Zealand Standard, i.e. AS/NZS 2208.
- (c) A letter or other code to indicate the plant of manufacture or supply.
- (d) Grade A or Grade B to indicate the grade of the material.
- (e) A number indicating the nominal thickness for standard glazing material in millimetre or a number indicating the minimum thickness for non-standard glazing material to the nearest tenth of a millimetre.
- (f) A letter or word or combinations thereof to indicate the type of glazing material used in the product, for example:

- (i) The letter 'T' or word 'toughened', indicating a toughened safety glass.
- (ii) The letter 'L' or the word 'laminated' indicating a laminated safety glass.
- (iii) The letters 'TL' indicating that the material is toughened laminated safety glass.

### TOUGHENED GLASS

When broken, toughened glass crumbles into small granular chunks of similar size and shape, which are less likely to cause injury compared to ordinary glass which splinters into random, jagged shards.

Toughened glass is made by a controlled process of heating the glass to about 600 °C followed by rapid cooling using compressed air. This cooling process causes the surface to contract, forming a rigid outer layer around the glass - making it much stronger than conventional glass and far more resistant to impact stress and thermal stress. Toughened glass has four to five times more strength than ordinary glass of the same thickness.

Prior to furnacing, the edges must be finished to a minimum standard whereby all edges are arressed by grinding a chamfer or bevel,

approximately 1 mm wide, on all sharp edges and corners.

Toughened glass is commonly used in the following applications:

- Human impact areas for safety, as defined in AS 1288
- Shopfronts and entrances
- Frameless glass doors
- Balustrades
- Structural glass assemblies and façades
- Overhead glazing
- Shower enclosures
- Interior partitions
- Spandrel glazing
- To minimise the risk of thermal stress fractures

Toughened glass, due to the nature of the process, is not as flat as float glass. Deviation or roller wave bow can vary with substance, tint or surface treatment and shape of the glass. Reflective, enamelled and sandblasted glasses have a greater tendency to bow. Bow tolerances are specified in AS/NZS 2208.

The edges of toughened glass must be handled with care. Particular attention must be taken to avoid edge damage which can result in spontaneous glass fracture.

Figure 7 Toughened Glass  
When broken, toughened glass fractures into small granules.  
Source: Shutterstock



Toughened glass can be specified to be Heat Soak treated. Heat soaking is a quality control check that detects and rejects most glass nickel sulphide inclusions. This significantly reduces the risk of toughened glass breakage.

AS 1288 requires heat soak testing of all toughened glass used in structural glass assemblies, overhead glazing, spandrel glass, balustrading and anywhere toughened glass is situated more than five metres above ground level.

### HEAT STRENGTHENED GLASS

Heat strengthened glass is manufactured using the same process as toughened glass but is NOT a safety glass. It has roughly twice the strength of ordinary glass of the same thickness and has the same thermal resistance properties of toughened glass. If broken, it forms large pieces. This product is used in building spandrels and windows not requiring safety glass.

### LAMINATED GLASS

Laminated glass is two (or more) pieces of glass, bound together by an interlayer. The interlayer, typically polyvinyl butyral (PVB), keeps the layers of glass bonded, even when broken, and prevents the glass from breaking up into large sharp pieces. This produces a characteristic 'spider web' cracking pattern when the impact is not sufficient to completely pierce the glass.

Laminated glass is normally used when there is a possibility of human impact or where the glass could fall if shattered. Skylight glazing and automobile windshields typically use laminated glass. In geographical areas requiring cyclone-resistant construction, laminated glass is often used in exterior storefronts, curtain walls and windows. The PVB interlayer may give the glass an improved sound insulation rating, particularly at high frequencies, due to

the damping effect, and also blocks up to 99 per cent of incoming UV radiation.

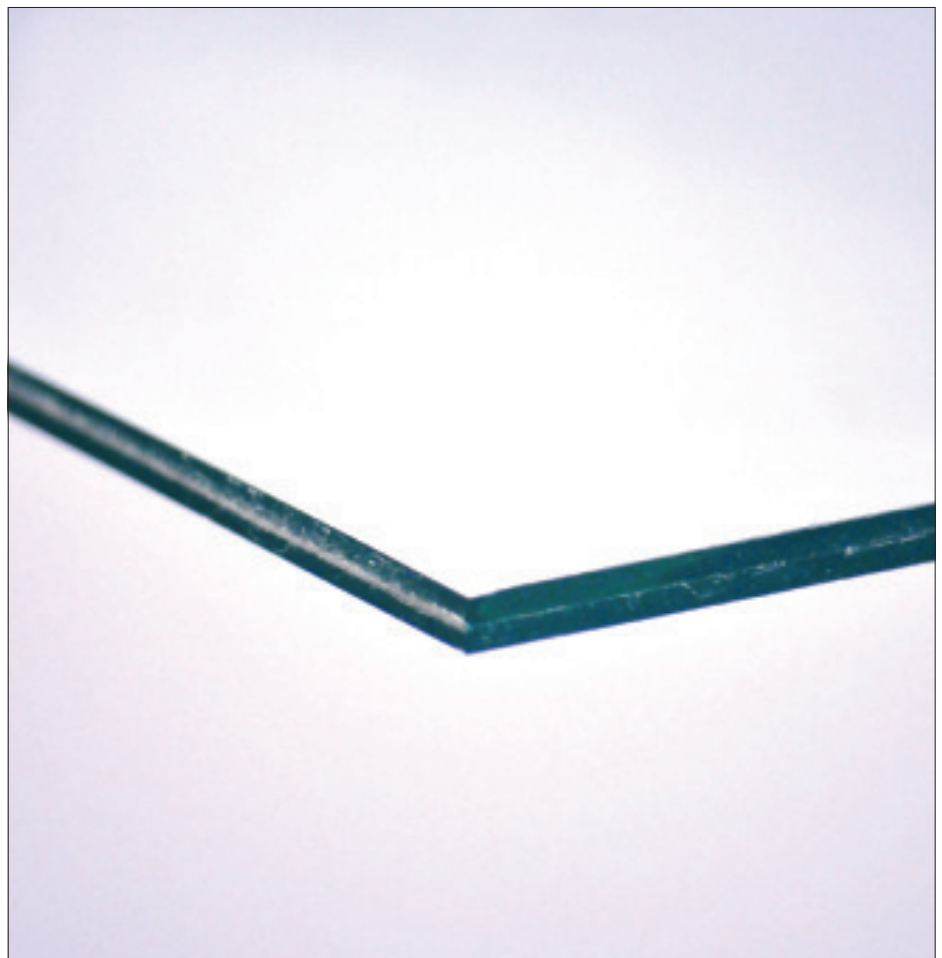
The performance of laminated glass can be varied by changing the number, thickness and type of each of the glass layers and the PVB interlayers to give a wide choice of products with one or more of the following functional benefits:

- Safety
- Security
- Bullet resistance
- Cyclone and explosion resistance
- Solar control and UV protection
- Noise control
- Privacy and decoration

Standard PVB interlayer thicknesses are 0.38, 0.76 and 1.52 mm. Special PVB interlayer thicknesses are available through specialist glass suppliers.

Figure 8 Laminated Glass

Source: Australian Glass and Window Association



# GLASS STANDARDS

There are a number of Australian Standards relevant to glass and glazing that specify the minimum compliance requirements. The main standards are:

## **AS 1288 GLASS IN BUILDINGS – SELECTION AND INSTALLATION**

AS 1288 sets out the data and procedures for determining the glass type and thickness requirements for all buildings. It is referenced in the National Construction Code (NCC). Glass design requirements are given for glazing based on the tensile stresses developed on the surface of the glass. The objective of the Standard is to provide uniform direction for the use and installation of glazing throughout Australia, to allow its use in legislation and to clarify technical definitions. In general, glazing must satisfy the design requirements for ultimate and serviceability limit states and human impact safety in accordance with the procedures given in the Standard.

## **AS/NZS 2208 SAFETY GLAZING MATERIALS IN BUILDINGS**

AS/NZS 2208 sets out the test requirements for the classification of safety glazing materials for use in buildings. The test requirements for the different glazing materials are designed to promote safety and to reduce or minimise the likelihood of cutting and piercing injuries from human impact. This applies to all safety glazing materials for compliance with AS 1288. The impact test assesses the fracture characteristics of a safety glazing material that has been broken under test conditions.

## **AS/NZS 4666 INSULATING GLASS UNITS**

AS/NZS 4666 sets out the requirements and guidelines for long-term testing, glazing, periodic manufacturing testing and other associated aspects of insulating glass units. Completed and fully cured units are subjected to a defined laboratory based testing regime of long-term cyclic, accelerated weathering and UV type tests that utilise laboratory controlled temperature ranges.

## **AS/NZS 4667 QUALITY REQUIREMENTS FOR CUT-TO-SIZE AND PROCESSED GLASS**

AS/NZS 4667 specifies the requirements for cut sizes of flat, clear, ordinary annealed glass; tinted heat-absorbing glass; glass used for Grade A safety requirements (i.e. toughened or laminated); patterned; decorative and wired glass; and processed laminated and toughened glass that is used for general and architectural glazing.

## **AS/NZS 4668 GLOSSARY OF TERMS USED IN THE GLASS AND GLAZING INDUSTRY**

AS/NZS 4668 provides manufacturers, suppliers and users of glass with definitions of terms used in the glass and glazing industry, specifically in building applications. It includes definitions of terms used in glass-related Australian and New Zealand Standards.

# REGULATORY REQUIREMENTS

As well as the Australian Standards that specifically relate to glass and the glazing products used in the building industry, there are also other requirements in the regulatory framework that affect glass and glazing. They include:

## THE NATIONAL CONSTRUCTION CODE

The National Construction Code (NCC) is an initiative of the Council of Australian Governments developed to incorporate all on-site construction requirements into a single code. The NCC is a uniform set of technical provisions for the design and construction of buildings and other structures and plumbing and drainage systems throughout Australia. The NCC is published in three volumes: The Building Code of Australia (BCA) is Volume One and Volume Two and the Plumbing Code of Australia (PCA) is Volume Three.

**VOLUME ONE** contains the requirements for:

- (a) All Class 2 to 9 buildings.
- (b) Access requirements for people with a disability in Class 1b and 10a buildings.
- (c) Certain Class 10b structures including access requirements for people with a disability in Class 10b swimming pools.

**VOLUME TWO** contains the requirements for:

- (a) Class 1 and 10a buildings (other than access requirements for people with a disability in Class 1b and 10a buildings).
- (b) Certain Class 10b structures (other than access requirements for people with a disability in Class 10b swimming pools).
- (c) Class 10c private bushfire shelters.

**VOLUME THREE** contains the requirements for plumbing and drainage associated with all classes of buildings.

The goal of the NCC is to enable the efficient achievement of nationally consistent, minimum necessary standards for safety (including structural safety and safety from fire), health, amenity and sustainability objectives.

## AS/NZS 1170 SERIES STRUCTURAL DESIGN ACTIONS

AS/NZS 1170 provides designers with general procedures and criteria for the structural design of buildings and structures. It outlines a design methodology that is applied in accordance with established engineering principles. It is comprised of 5 parts (numbered 0 – 4):

- Part 0: General Principles
- Part 1: Permanent, Imposed and Other Actions
- Part 2: Wind Actions
- Part 3: Snow and Ice Actions
- Part 4: Earthquake Actions

## AS 4055 WIND LOADS FOR HOUSING

AS 4055 provides designers, builders and manufacturers of building products that are affected by wind loading with a range of wind speed classes that can be used to design and specify such products for use in housing as defined within the limitations in this standard. The standard relates specifically to building Classes 1 and 10 (as defined by the NCC) and within geometric limits given in the standard. A system of 10 classes of wind loads is set out in the standard for the serviceability and ultimate limit states and incorporates both non-cyclonic (N) and cyclonic (C) regions.

The selection of wind speed class for a house depends on the conditions at the site:

- (a) The geographic wind speed region of the site (Region A, B, C or D, as given in AS/NZS 1170.2).
- (b) The terrain category that surrounds it or is likely to surround the site within the next five years (TC1, TC1.5, TC2, TC2.5 or TC3).
- (c) The topographic class of the site (T0, T1, T2, T3, T4 or T5).
- (d) The shielding class of the house (FS, PS or NS).

## AS 2047 WINDOWS AND EXTERNAL GLAZED DOORS IN BUILDINGS

AS 2047 sets out the requirements for the construction and installation of windows, sliding and swinging glazed doors (including French and bi-fold), adjustable louvres, shopfronts and window walls with one-piece framing elements. It provides window designers and manufacturers with generic requirements for windows in buildings, setting out the performance requirements and specifications in the design and manufacture of all windows, regardless of materials.

## AS 1926.1 SWIMMING POOL SAFETY PART 1 SAFETY BARRIERS FOR SWIMMING POOLS

AS 1926.1 provides the requirements for safety barriers, including glass barriers, around pools. Glass barriers under this standard must also meet the requirements of AS 1288.





# DESIGN FOR WIND LOADS

The principal load applied to glass in an exterior wall is, in most cases, the net pressure difference caused by local wind conditions. It is important to understand this type of loading to ensure proper design.

The design wind load can be determined using these primary documents:

**AS 4055** – the ultimate and serviceability limit state design wind pressures for glass in walls that are within the AS 4055 definition for housing.

**AS/NZS 1170.2** – the ultimate and serviceability limit state design wind pressures for glass in walls that are within the limitations of AS/NZS 1170.2.

The design wind load is determined using these standards and is dependent on the following:

1. Regional wind speed.
2. Terrain category.
3. Local topography.
4. Height, size, shape and orientation of the building.
5. The effects of shielding.

Alternately, guidance is provided in the secondary documents **AS 1288** Appendix A and **AS 2047** Appendix A.

For all buildings and structures that are not covered by AS/NZS 1170.2, an engineered solution is required.



Figure 9 Storm Over the Gold Coast, 2010

Figure 10 Australian Wind Regions  
Source: AS/NZS 1170.2  
Photographer: Paul Bica

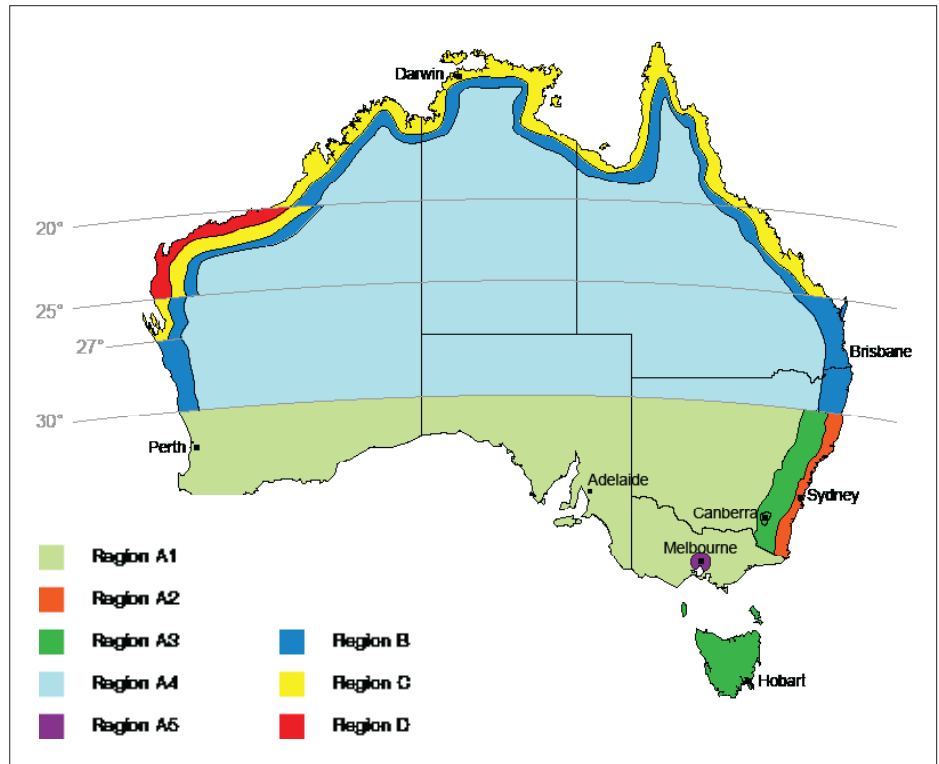


Figure 11 Terrain Category 1: Enclosed Water Surfaces  
This includes rivers, canals, lakes and enclosed bays, extending more than 200 m.  
Photographer: Chris Clarke



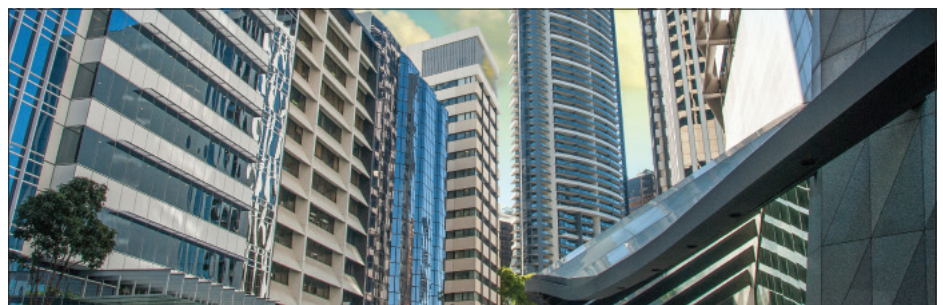
Figure 12 Terrain Category 2: Open Water and Oceans  
Photographer: Gary Tindale



Figure 13 Terrain Category 3: Suburban Housing  
Source: Shutterstock



Figure 14 Terrain Category 4: City Centre  
Source: Shutterstock



### REGIONAL WIND SPEED

Regional wind speeds for all directions are based on three second gust wind data that are provided in Section 3 of AS/NZS 1170.2 and are determined for a specific building site based on its location within Australia as defined by Figure 10.

### TERRAIN CATEGORY

The terrain over which the approaching wind flows toward the building is assessed on the basis of the following category descriptions:

(a) Category 1 – Exposed open terrain

- with few or no obstructions and enclosed water surfaces.
- (b) Category 2 – Open water surfaces, open terrain or grassland with few, well scattered obstructions having heights generally from 1.5 m to 10 m.
- (c) Category 3 – Terrain with numerous closely spaced obstructions 3 m to 5 m high, such as areas of suburban housing, light industrial estates or dense forests.
- (d) Category 4 – Terrain with numerous large, high (10 m to 30 m high) and closely spaced obstructions, such as large city centres and well developed industrial complexes.

### LOCAL TOPOGRAPHY

Topography can have a significant influence on local wind speed which affect the wind loads applied to a building based on its location on a hill, ridge or escarpment and is dependent on the height and maximum slope of the hill, ridge and escarpment. Topography is classified as T0, T1, T2, T3, T4 or T5, as specified in Table 1 for AS 4055. A topographic multiplier is used in AS/NZS 1170.2.

Table 1 AS 4055 Topographic Class Definitions

Maximum Slope ( $\theta$ )	Site Location (see Figure 15)					
	Bottom Third Zone	Middle Third Zone	Top Third Zone			Over the Top Zone
			H ≤ 10m	H ≤ 30m	H ≥ 30m	
$\theta < 1:20$ ( $\theta < 2.9^\circ$ )	T0	T0	T0	T0	T0	T0
$1:20 \leq \theta < 1:10$ ( $2.9^\circ \leq \theta < 5.7^\circ$ )	T0	T0	T1	T1	T1	T0
$1:10 \leq \theta < 1:7.5$ ( $5.7^\circ \leq \theta < 7.6^\circ$ )	T0	T1	T1	T2	T2	T0
$1:7.5 \leq \theta < 1:5$ ( $7.6^\circ \leq \theta < 11.3^\circ$ )	T0	T1	T2	T2	T3	T1
$1:5 \leq \theta < 1:3$ ( $11.3^\circ \leq \theta < 18.4^\circ$ )	T0	T2	T2	T3	T4	T2

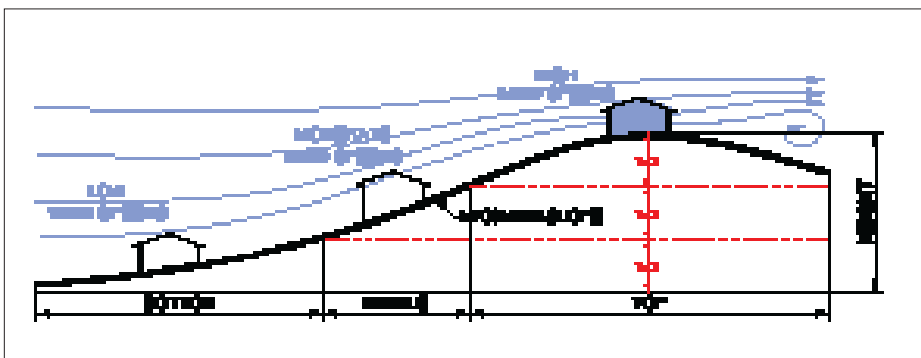
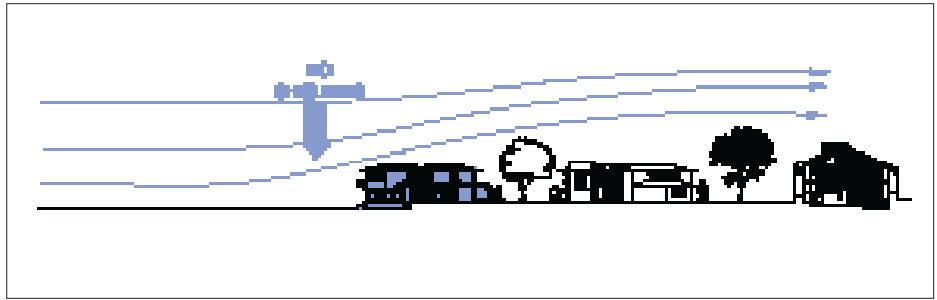


Figure 15 Topographic Class

Source: Australian glass and Window Association

Figure 16 No Shielding  
Source: Australian Glass and Window Association



## BUILDING HEIGHT, SHAPE AND ORIENTATION

The height, size, shape and orientation of a building all play a major role in determining the wind loads applied to the building and external glazing. Wind speed, and therefore wind pressure, increases with height above ground level. When the wind blows perpendicular to a building face, it is slowed down with a consequent build-up of pressure against that face. At the same time, it is deflected and accelerated around the end walls and over the roof, creating a suction or negative pressure on these areas. A large eddy is created behind the building, which exerts suction on the leeward face. Corner zones and other areas of discontinuity, such as roof ridges, have higher negative (outward) loads than flat walls away from discontinuities. Therefore, the negative loads on glass at corners are generally higher than at intermediate areas.

Engineers and designers must consider the effects of the building design with regard to principles such as aerodynamic shape factors, internal pressure coefficients, frictional drag forces and dynamic response factors.

## THE EFFECTS OF SHIELDING

The shielding effects of buildings and other obstructions in the general vicinity of a building must be considered when determining the wind loads applied. Shielding is treated differently in AS 4055 and in AS/NZS 1170.2.

For housing, AS 4055 provides that the effects of shielding are classified as either No Shielding (NS), Partial Shielding (PS) or Full Shielding (FS).

- **No Shielding** applies where there are no permanent obstructions (that are of a similar size to the house) to impede wind speed or where there are less than 2.5 obstructions per hectare, such as a row of houses or single houses abutting open parklands, open water or airfields. All houses with topography of T4 and T5 have no shielding.
- **Partial Shielding** applies to intermediate situations where there are at least 2.5 houses or sheds per hectare, such as acreage type suburban development or wooded parkland. The second row of houses abutting open parkland, open water or airfields are classified as having partial shielding.
- **Full Shielding** applies where at least two rows of houses or similar size permanent obstructions surround the house being considered. The application of full shielding shall be appropriate for typical suburban development greater than or equal to 10 houses or similar size obstructions per hectare.

For all other buildings, shielding is determined through the application of a shielding multiplier as per the provisions of AS/NZS 1170.2.

---

More information can be found in the AGWA Key Message on Exposed Sites.

---

## SPAN OF GLAZING

The allowable span for a given glass thickness will vary based on the wind-load the glass will be subjected to. Higher wind loads will require shorter spans or thicker glass to be compliant.

Span is defined as the dimension between supports. For panels supported on all four edges, for example, a typical window where the glass is held by a frame on all four sides, the span is the smaller sight size dimension. Where glazing is supported on only two sides, the span is the distance between the supports.

The maximum span for a given standard nominal thickness of ordinary annealed, laminated, heat-strengthened and toughened glass is determined in accordance with AS 1288 Section 3. This sets out a deemed-to-comply methodology for determining the minimum glass thickness to be used to resist the serviceability and ultimate limit state design wind pressures for the size and/or span of the glass. Alternatively, Section 4 can be used to determine the maximum span for glass panels, subject to wind loading.

Supplement 1 of AS 1288 provides a simplified method of determining minimum glass thickness for given wind loads. The supplement consists of 95 tables for glass thickness calculated for ULS wind pressure for four-edge support in the range of 0.6 kPa to 10.0 kPa and 59 tables for thickness calculated for deflection for four-edge support in the range of 0.4 kPa to 6.2 kPa. There are also four tables for glass thickness calculated for ULS wind pressure and four for deflection at SLS wind pressure for two-edge support. The tables apply to monolithic annealed, laminated annealed, heat-strengthened and toughened glass.





# HUMAN IMPACT SAFETY

Glass is a brittle material. The application of AS 1288 Section 5 requires the use of either safety glass or thicker annealed glass to reduce the risk of injury from human impact. This does not assume that the glass will not break under all human impact conditions, but rather that it will not break under the most likely forms of human impact. When broken, the likelihood of cutting or piercing injuries will be minimised by virtue of the protection given to the glass by its limited size, increased thickness or by its fracture characteristics.

Accident statistics show that glazing in some locations in buildings is more vulnerable to human impact than in others. These critical locations include:

- (a) In and around doors (particularly in side panels which may be mistaken for doors).
- (b) Panels mistaken for a doorway or opening.
- (c) Panels at low levels in walls and partitions.
- (d) Bathrooms, spa rooms and ensuites.
- (e) Buildings associated with special activities, for example, gymnasiums, enclosed swimming pools, etc.
- (f) Schools and child care facilities.
- (g) Nursing homes and aged care facilities.

Where glazing is within 2000 mm above the finished floor level (or external ground level) of all buildings it is considered likely to be subjected to human impact and must comply with the human impact safety requirements of AS 1288 Section 5.

Figure 17 Manifestation

Source: Shutterstock



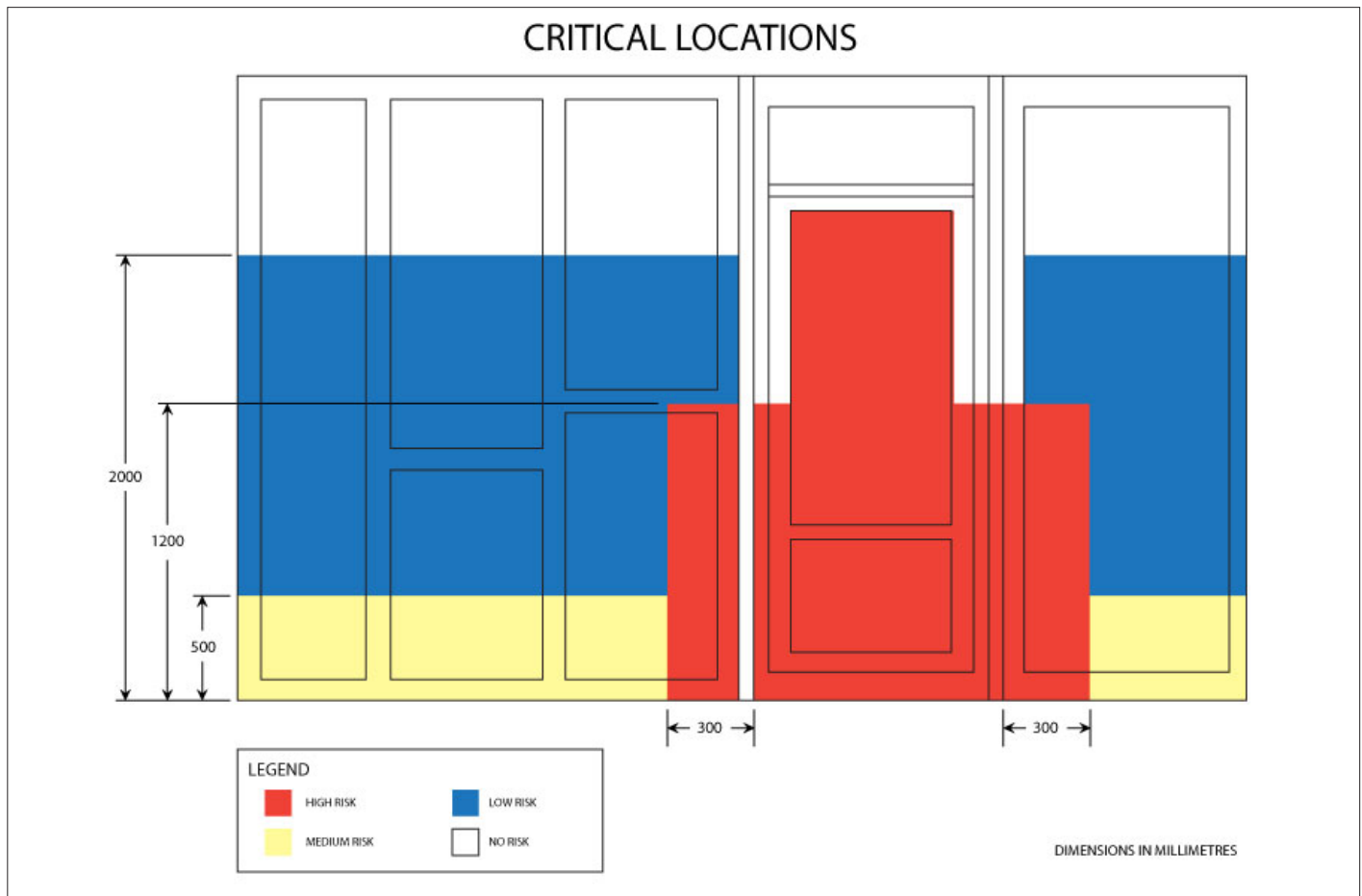


Figure 18 Human Impact Critical Locations  
Source: AS 1288 and Australian Glass and Window Association

## CRITICAL LOCATIONS

Figure 18 illustrates the areas considered likely to be subjected to human impact, including:

- Glazing in doors.
- Glazing in side panels, with the nearest vertical sightlines less than 300 mm from the nearest edge of the doorway opening.
- Glazing within 500 mm of the finished floor level.

## MAKING GLASS VISIBLE

Where glass is used in a door, side panel or a panel capable of being mistaken for a doorway or opening and it is not made apparent by transoms, colonial bars or other components of the glazing system, or other decorative treatments, such as being opaque or patterned, the glass must be marked to make it visible.

This can be achieved by the application of a continuous opaque band or repeated markings not less than 20 mm high, or a broken line or patterns (such as company logos) that contrast with the background. Marking must be located at a height of not less than 700 mm to the upper edge of the band and not more than 1200 mm to the lower edge of the band.

The AGWA recommends that where the band is not continuous, spacing between groups of markings should not exceed 1.5 times the maximum height of the marking or logo and that the band or markings extend to 60 per cent of the visible daylight opening width (Figure 19).

Installing glazing without manifestation where AS 1288 requires its application constitutes non-compliance with AS 1288, AS 2047 and the NCC.

A band or marking is not required when any of the following applies:

- I. The width of the glazing is no greater than 500 mm at any part (with faceted glazing this applies to the overall panel assembly – not individual glass panels).
- II. There is no glazing within 500 mm of the finished floor level.
- III. The height of the glass panel is no greater than 1000 mm at any part.
- IV. The glass is patterned, leadlight or opaque.
- V. A handrail, chair rail or transom is fitted between 700 and 1000 mm above floor level.
- VI. Glass louvres less than 230 mm in width.
- VII. The surface level outside the window is 1 m or more below the internal floor level.



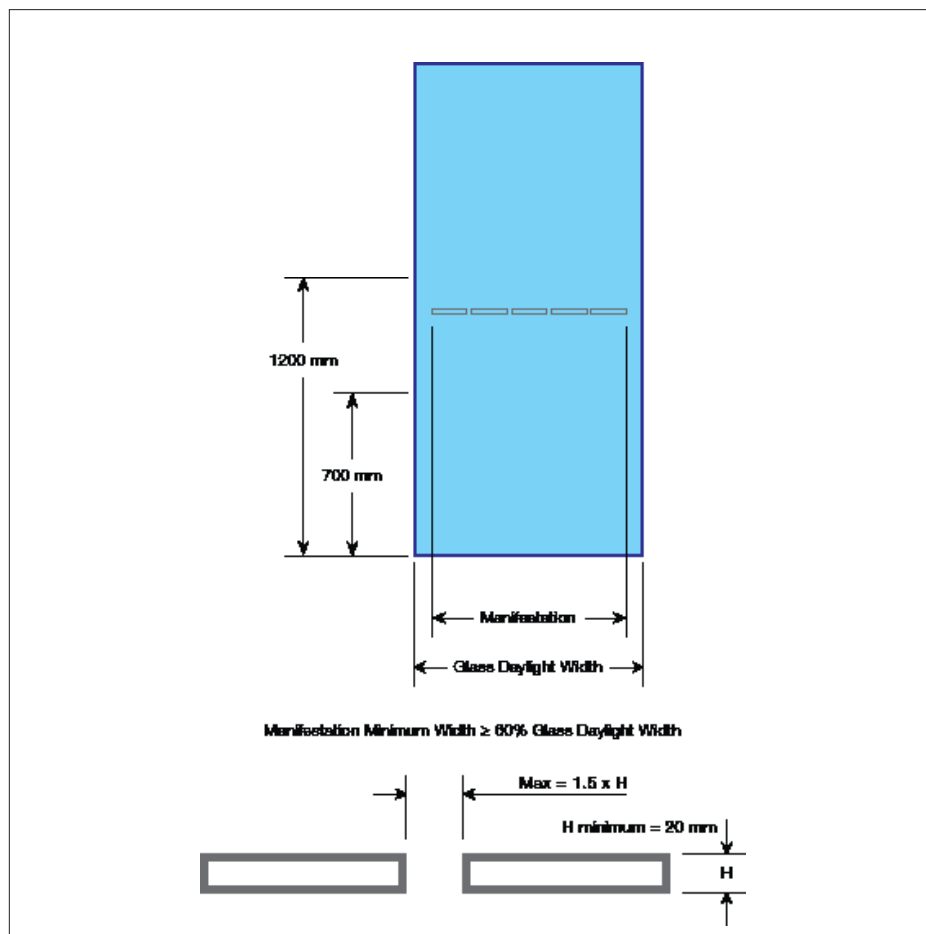


Figure 19 Manifestation Recommendations

Source: Australian Glass and Window Association

The AGWA recommends glass suppliers and glaziers:

- Ensure that manifestation has some sense of permanency which includes etched or applied marks that are difficult to remove (kiss or security cut).
- Have a clause in the supply contract that states that these products have been manifested in accordance with the NCC and AS 1288:2006, clause 5.19, and should not be removed. Make sure that the contract is signed.
- Never, during installation or delivery, indicate or agree that manifestation can be removed.

In situations where a building (or parts of a building) is intended for public access, it is required to meet certain access requirements for people with a disability, in which case, additional provisions for manifestation are required. Section D3.12 of the NCC

requires that glazing in an accessway, such as frameless or fully glazed doors, sidelights and any glazing capable of being mistaken for a doorway or opening (where there is no chair rail, handrail or transom), must be clearly marked in accordance with AS 1428.1. This standard specifies the design requirements to provide access for people with disabilities.

Clause 6.6 of the standard provides the technical specification for the application of visual indicators on fully glazed doors and sidelights. The purpose of the visual indicator is to inform all members of the community, particularly those with a vision impairment, of the presence of the fully glazed panels in their path of travel. Visual indicators are required to be a solid contrasting line, at least 75 mm wide and between 900 mm and 1000 mm above the finished floor level and extending the full width of the glazed panel.

The contrasting line must provide a minimum of 30 per cent luminance contrast against the floor surface or surfaces within two metres of the glazing. This is usually achieved by using either very dark or very light materials and verified using the procedures described in AS 1428.1 Appendix B.

More information can be found in the AGWA Key Message on Manifestation.

## DOORS AND SIDE PANELS

The requirements for the glazing of doors are the same for residential and non-residential use. Glazed doors of all operational types are included, for example, hinged, sliding, folding and stacking, etc. Glazing in doors and glazing within 300 mm of door openings with the nearest vertical sightlines less than 300 mm from the nearest edge of the doorway opening, wholly or partially within 1200 mm from floor or ground level, must be Grade A safety glass that complies with the maximum areas of safety glazing as set out in AS 1288 Table 5.1, with a few specific exceptions:

- For 3 mm and 4 mm decorated annealed glass, the maximum area shall not exceed 0.1 m<sup>2</sup> with a maximum pane width of 125 mm.
- A minimum of 5 mm annealed glass may be used up to a maximum area of 0.3 m<sup>2</sup>.
- Individual pieces of ordinary annealed glass incorporated in leadlights may be used, to a maximum area of 0.05 m<sup>2</sup> with a minimum nominal thickness of 3 mm. Larger areas of ordinary annealed glass are not permitted regardless of glass thickness.
- For 5 mm and 6 mm decorated annealed glass, the maximum area shall not exceed 0.26 m<sup>2</sup> with a maximum pane width of 300 mm.
- For annealed glass with a thickness of 10 mm or greater, with or without bevelled edges, the maximum area shall not exceed 0.5 m<sup>2</sup>.

Refer to AS 1288 Clause 5.2 for the full list of exceptions.

### GLAZING CAPABLE OF BEING MISTAKEN FOR A DOORWAY OR OPENING

For glazing that may be capable of being mistaken for a doorway or an opening that could provide access to, or egress from, one part of a building to another, or an opening between the inside and the outside of a building, which can result in human impact, Grade A safety glass must be used in accordance with AS 1288 Section 5. Glazing that conforms to any one of the following is not considered to be capable of being mistaken for a doorway or opening:

- (a) The sight size width is less than or equal to 500 mm.
- (b) The sight size height is less than or equal to 1000 mm.
- (c) The lowest sightline of the opening, as shown in Figure 18, is 500 mm or greater above the floor or ground level.
- (d) The glazing is opaque, patterned or a leadlight.
- (e) Where a crash/chair rail, handrail or transom is provided and located with its upper edges not less than 700 mm or its bottom edge not more than 1000 mm above the floor level.
- (f) The panels are louvres with a blade width (i.e. shortest side) not greater than 230 mm.
- (g) The glazing protects a difference in level of 1000 mm or more.



Figure 20 Low Level Glazing and Full Height Windows  
Source: G.James

### LOW LEVEL GLAZING AND WINDOWS THAT ARE FULL HEIGHT

Low level glazing, where the lowest sightline is less than 500 mm from the floor or ground level, is subject to human impact and must be Grade A safety glass in accordance with AS 1288 Table 5.1. If fully framed, ordinary annealed glass may be used provided it is not less than 5 mm minimum nominal thickness up to a maximum area of 1.2 m<sup>2</sup>. Larger areas of ordinary annealed glass are not permitted regardless of glass thickness.

**NOTE:** On tall Double Hung Windows either sash could be within 500 mm of floor level so both sashes must comply with human impact clauses.

### BATHROOM, ENSUITE AND SPA ROOM GLAZING

Fully framed glazing, including mirrors, within 2000 mm above the floor level in bathrooms, ensuites and rooms or enclosures containing spa pools must be Grade A safety glass or Grade B safety glass in accordance with the requirements of AS 1288 Table 5.1.

Partly framed glazing, with one unframed edge or two opposite unframed edges, must be glazed with Grade A toughened safety glass or toughened laminated safety glass in accordance with AS 1288 Table 5.4.

Ordinary annealed glass, including mirrors, may be used provided it is fully backed by and completely adhered to a solid material in a way so that all pieces

will remain bonded to the backing in the event of glass breaking.

Frameless shower doors or panels must be glazed with Grade A toughened or toughened laminated safety glass with a minimum thickness of 6 mm, in accordance with AS 1288 Table 5.4.

### GLAZING IN STAIRWAYS

Glazing, including mirrors, in stairways within 2000 mm horizontally and at right angles to the bottom riser of each stair flight, and within 1000 mm and parallel to any part of the stair flight or landing, shall be Grade A safety glass in accordance with Table 5.1 of AS 1288. Safety glass is not required where the glazing is protected by a solid barrier that is not less than 1000 mm in height.



### INTERNAL AND EXTERNAL SHOPFRONTS AND PARTITIONS

Clauses 5.6 and 5.7 of AS 1288 prescribe the minimum glazing requirements for shopfront glazing, which generally must be Grade A safety glass with few exceptions.

### SCHOOLS, EARLY CHILDHOOD CENTRES, AGED CARE BUILDINGS AND NURSING HOMES

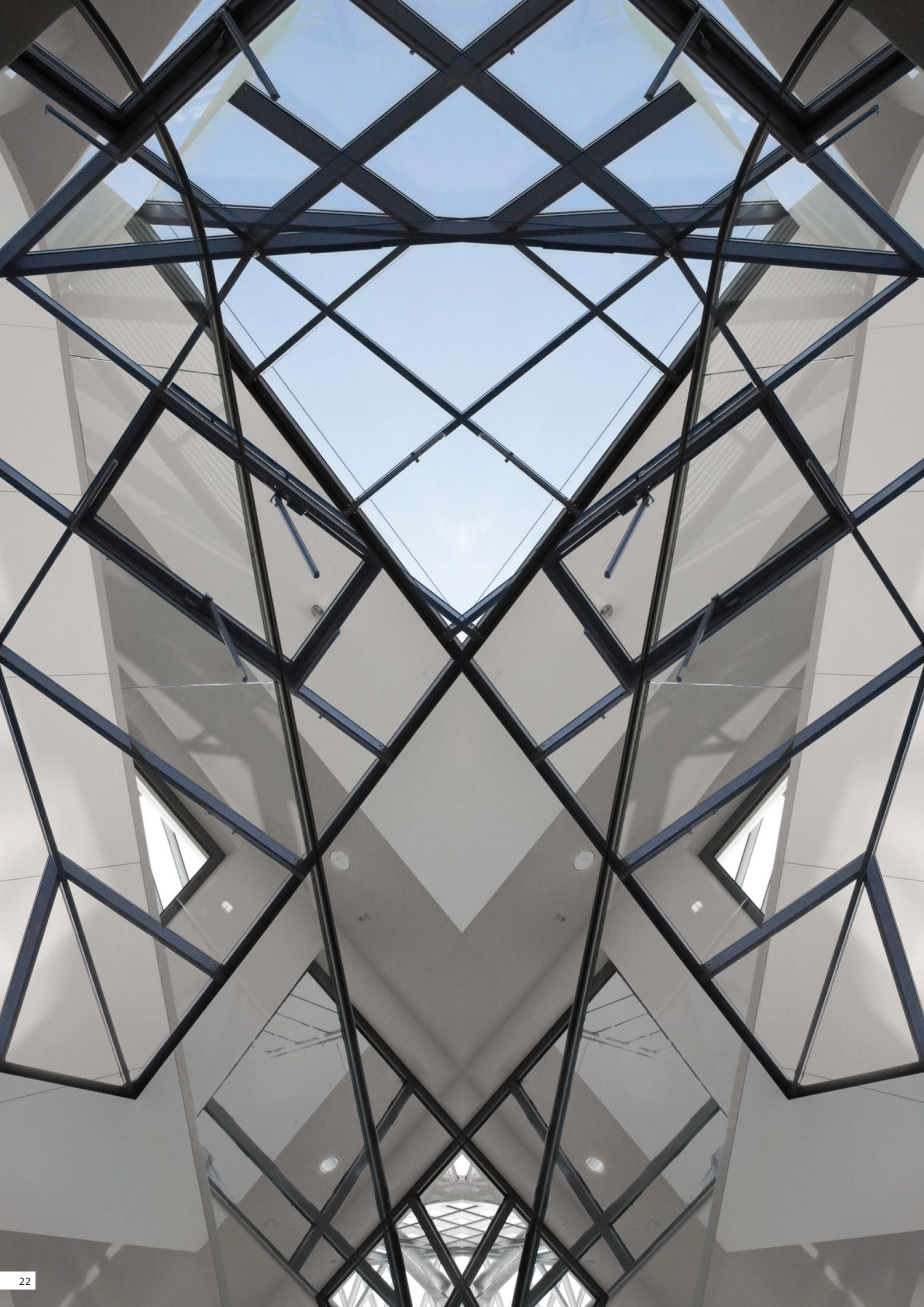
Requirements for special purpose buildings such as schools, early childhood centres, aged care buildings and nursing homes vary from other buildings. The primary point of difference is the height threshold from the floor level where human impact is likely to occur. AS 1288 recognises this and requires consideration be given to glazing within 1000 mm of the finished floor level in schools and early childhood centres and 1500 mm from floor level in aged care buildings and nursing homes.

### INSULATING GLASS UNITS

Where insulating glass units are used in situations likely to be subjected to human impact on either side, both panes of the unit must meet the requirements of Section 5 of AS 1288. The maximum areas specified in this Section can be multiplied by 1.5, provided that each of the component glass of the unit otherwise complies. In situations where access is restricted to one side of the unit, then only the accessible side must be considered for human impact, without the application of the 1.5 factor.

Figure 21 Shopfront Glazing  
Source: Viridian





# SLOPED OVERHEAD GLAZING



The requirements for sloped overhead glazing are covered in Section 6 of AS 1288. The necessary calculations taken into account include:

- (a) Wind Actions
- (b) Dead Loads
- (c) Live Loads
- (d) Other specific loads, as required

**NOTE:** Other loads can include imposed live loads for maintenance and cleaning that the designer may require.

The standard requires specifiers to consider the worst load combination effect of all imposed loads to be taken as the ultimate limit state design pressure and used to determine the minimum glass thickness to resist the uniformly distributed loads. The glass thickness used must be the highest determined to resist both the uniform design load and design point load.

Generally, sloped overhead glazing 3.0 m or more above the floor must be Grade A laminated safety glass.



Figure 22 Sloped Overhead Glazing  
Source: Shutterstock



# GLAZING FOR BALUSTRADES AND POOL FENCING



## BALUSTRADES

Grade A safety glass must be used in all balustrades. The standard nominal thickness of glass for a given situation is determined using Section 3 of AS 1288.

Glass balustrade panels are classified as either structural balustrade panels or infill balustrade panels.

Structural balustrade panels are those where the structural support for the balustrade system is provided by the glass itself. They may have a non-load-supporting handrail, where the glass supports a handrail that is fixed to the glass and relies on the glass for structural support; an interlinking handrail where the handrail is non-load-supporting, unless a panel breakage occurs, and is connected to adjacent panels of glass; or the top edge of the glass itself may act as the handrail.

Balustrade infill panels do not support the hand-rail, but are fitted in between supports. They are not required to resist line loads along their top edge as the handrail provides this support. Load-supporting handrails are mechanically fixed to the structure, independent of the glass, but the glass can be connected to it.

The design of balustrades for the stability, ultimate strength and serviceability limit states must be calculated to account for the imposed live and wind load actions specified in AS/NZS 1170.0, AS/NZS 1170.1 and AS/NZS 1170.2, other specific loads as required and the design load combinations as specified in AS/NZS 1170.0.



AS 1288 does not cover every aspect of glass design, but the intention is reasonably clear.

For any application involving glazing outside the scope of the tables, charts or formulas provided in AS 1288, an engineering design is required to ensure compliance with the current standard. This means that all spigot and anchor fixings are outside the deemed-to-satisfy provisions of Section 7 of AS 1288 and require an engineering certification to confirm adherence to the NCC performance requirements.

When the standard was written, it did not consider structural interlayers as solutions. All balustrades using SGP DuPont interlayer are not covered by AS 1288 and need to be certified as a performance method.

If any material is used that meets the loading and fundamental requirements of a balustrade, then a site specific, independently engineered performance solution will be within the NCC guidelines.

## SWIMMING POOL FENCES

Swimming pool fences are covered in AS 1926.1 Swimming Pool Safety Part 1 Safety Barriers for Swimming Pools. This standard references AS 1288 so glass fences must not only meet the requirements of AS 1926.1 but also the requirements of AS 1288 for all loads including human impact. If there is a conflict between the two standards, the most stringent requirement must be met. Glass panels must be 1200 mm high and glass gates with a top and bottom pivot hinge must have a bottom gap of not more than 100 mm.

Figure 23 Balustrade Designs Not Covered by AS 1288

Source: Hanlon Windows (top), Evolution Window Systems (middle), Vision 3 Window Systems (bottom)





# FRAMED, UNFRAMED AND PARTLY FRAMED GLASS ASSEMBLIES



Framed, unframed and partly framed glass assemblies require different installation techniques to ordinary framed panels. The structural integrity of these assemblies depends upon the interaction between the glass panels, the linking and supporting components and the surrounding supports. Typically these types of assemblies include:

- Faceted glazing
- Butt-joint glazing
- Fin-supported glazing
- Unframed toughened glass assemblies



The glass type (whether annealed, laminated safety glass, heat-strengthened or toughened safety glass) is selected in accordance with all the relevant requirements of AS 1288, as appropriate to the location and the application of the glazing.



Figure 24 Framed, Unframed and Partly Framed Glazing  
Source: Shutterstock



# SHOWER SCREENS



Shower screens are covered in AS 1288 and have a high risk for human impact.

The type and thickness of the glass used is based on the framing type.

For fully framed shower screens either Grade A or Grade B glass can be used. Table 5.1 of AS 1288 is used to determine the type and thickness of the glass based on the area of the glass.

Grade A toughened or laminated toughened safety glass must be used for both partially framed and frameless shower screens. The thickness of glass is dependent on the maximum area based on Table 5.4. In the case of partially framed shower screens, Grade A toughened safety glass with a nominal thickness of 5 mm can be used provided the maximum area is not more than 2.2 m<sup>2</sup>.

Figure 25 Glazed Shower Screens

Source: Viridian



# ENERGY EFFICIENT GLAZING

## ABOUT ENERGY EFFICIENCY

Windows and glazed doors are part of the thermal fabric of a building and have a large impact on the energy efficiency and thermal comfort of a building. While glazing does not directly consume energy, it will affect the amount of energy that is used by a building's air conditioning system in order to maintain a level of thermal comfort that is expected in modern day buildings. The choices made in the selection of glazing can dramatically affect the performance of the building's operation costs and comfort over the life of the building.

Analysis of Australian houses has shown that while glazing can make up as little as 8 per cent of the building fabric (floors, walls, roof) it can, for example, in Brisbane, account for as much as 87 per cent of the heat gain and 48 per cent of the heat loss for a building when an aluminium framed window with uncoated single glass is used.

All states and territories in Australia currently have regulatory requirements for the energy efficiency performance of buildings in the National Construction Code (NCC) which requires they be assessed for their ability to efficiently use energy.

As the stringency of the NCC provisions has tightened, glazing with increased performance has been required to meet the minimum performance requirements. This has led to an increase in Low-E glass, double glazing and thermally efficient windows being specified.

There are three main ways that glazing allows the transfer of heat:

1. The direct transfer through the glazing via conduction, convection and radiation.
2. The radiation of heat through the window via direct solar or reflected solar.
3. Uncontrolled air leakage through and around the window system.

In order for the glazing to provide a thermally efficient design, it must be considered together with the building design to:

- Reduce conduction of heat through the glazing.
- Exclude heat gains in hot periods.
- Allow passive heat gains in cold periods.
- Control unwanted air infiltration.
- Allow ventilation.
- Encourage natural light.

## ENERGY EFFICIENT GLAZING ASSESSMENT

Glazing is assessed for its performance in four different ways; U-value, Solar Heat Gain Coefficient (SHGC), Visible Transmittance (VT) and Air Infiltration.

The measurement of the U-value, SHGC and VT is conducted using advanced computer software systems such as OPTICS, WINDOW and THERM, developed by Lawrence Berkeley National Laboratories in the United States. OPTICS allows the analysis of glass properties across a wide spectrum of ultra violet, solar, visible and infra-red wavelengths. The WINDOW and THERM software simulates the effects of a temperature difference between the exterior and interior using a specific direct solar load to accurately calculate the amount of conduction, direct solar transmission and visible transmission through glass and window systems.

Air Infiltration is measured as part of the AS 2047 test requirements.

### U-VALUE

U-value (expressed as  $U_w$  for window systems and  $U_g$ ,  $U_{cog}$  or  $U_{glass}$  for glass only) measures how readily glass or a window system conducts heat. It is a measure of the rate of non-solar heat loss or gain through it. The U-value is a combined measure of the conductive, convective and non-solar radiative transfer through the glazing or glass. The rate of heat for a glazing system is indicated in terms of the U-value, including the effect of the frame, glass, seals and any spacers. The lower the U-value, the greater the product's resistance to heat flow and the better its insulating value.

### SOLAR HEAT GAIN COEFFICIENT

The Solar Heat Gain Coefficient for windows (expressed as  $SHGC_w$  for window systems and  $SHGC_g$ ,  $SHGC_{cog}$  or  $SHGC_{glass}$  for glass only) measures how readily heat from direct sunlight flows through a window system or glass. The SHGC is the fraction of incident solar radiation admitted through a product, directly transmitted as well as absorbed and subsequently released

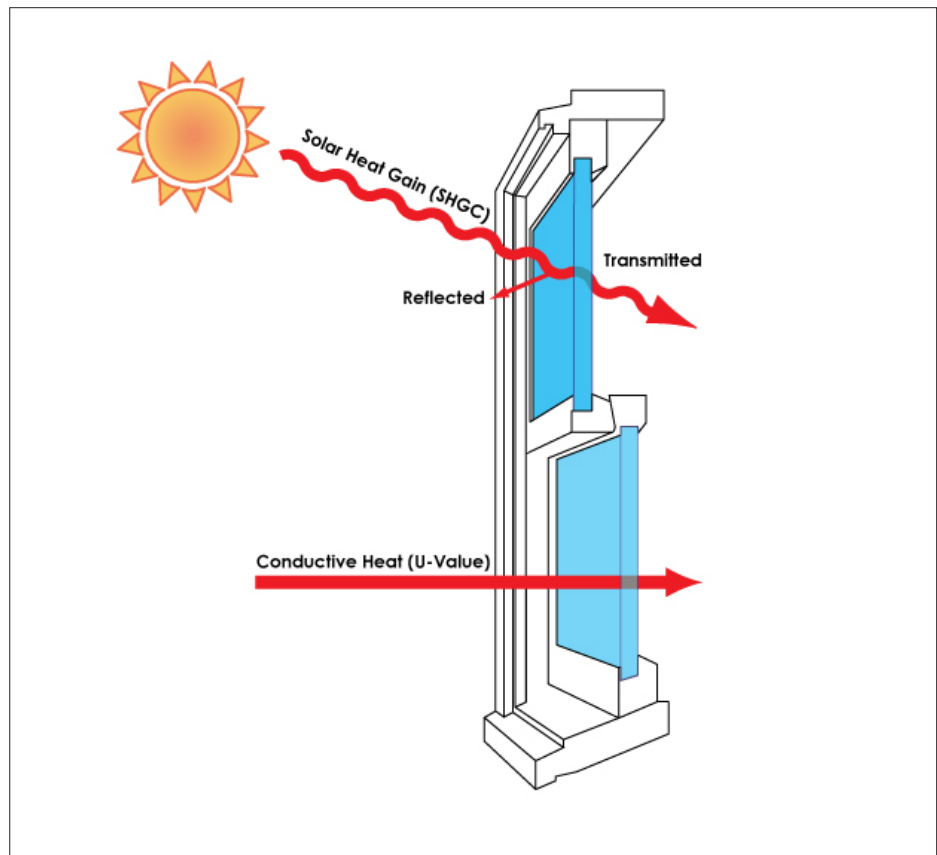


Figure 26 Energy Efficiency of a Window

inward. SHGC is expressed as a number between 0 and 1. The lower a window's SHGC, the less solar heat it transmits.

### VISIBLE TRANSMITTANCE

The Visible Transmittance ( $T_v$ ) (expressed as  $T_{v,w}$  for window systems and  $T_{v,g}$ ,  $T_{v,cog}$  or  $T_{v,glass}$  for glass only) measures the amount of light visible to the human eye that passes through a window system or glass. The  $T_v$  is expressed as a number between 0 and 1. The lower a window's  $T_v$ , the less light the product transmits. Low  $T_v$  can mean that the low internal light levels can increase the need for artificial lighting.

### ENERGY EFFICIENCY OF GLASS

When selecting glass to be used in a window system it is useful to understand the performance of the glass on its own. For this reason, many

glass manufacturers publish glass performance guides that allow the comparison of glass types against each other as glass only performance results (indicated as  $U_g$ ,  $U_{cog}$  or  $U_{glass}$  and  $SHGC_g$ ,  $SHGC_{cog}$  or  $SHGC_{glass}$ ). While these glass only performances are useful for comparing glass on a like-for-like basis, they cannot be used for compliance with the NCC, BASIX or NatHERS as they all require values for the entire window system.

### ENERGY EFFICIENCY OF WINDOW SYSTEMS

Due to the significant impacts of the framing system on the thermal performance of a glazing system, the whole of window system performance (indicated as  $U_w$  and  $SHGC_w$ ) should be compared when selecting products.

The Window Energy Rating Scheme (WERS) website lists many performance

results for glazing systems that can be used by WERS members for compliance with the NCC. For compliance purposes, the glazing must be assessed for the combined effect of glass and frame according to the protocols and procedures of the Australian Fenestration Rating Council (AFRC).

## REGULATORY REQUIREMENTS

Energy efficiency of buildings has been a key part of the NCC in Australia since 2003 as a way to improve the quality of buildings and to reduce the impact of building stock on greenhouse gas emissions. The requirements for building performance are set out in the NCC under:

- NCC Volume 1 Section J for Building Classes 2-9
- NCC Volume 2 Part 3.12

The performance requirements for buildings in Australia do not specify the minimum performance of windows but rely on a building modelling method to account for climate variation and to allow products to be tailored. There are many different assessment methods that allow the full assessment of buildings including:

- For Residential Buildings:
  - The NCC Glazing Calculator – Volume 2
  - The NatHERS Accredited Software
    - AccuRate
    - FirstRate
    - BERS Pro
  - BASIX (NSW Only)
- For Commercial Buildings:
  - The NCC Glazing Calculator

Each of the tools require that the glazing performance is input for every window on each elevation of the building in order to determine that the overall building performance meets the requirements specified in the NCC. Once a compliant building has been achieved, then the performance of the window systems must be met in order to prove compliance with the NCC.

## A GUIDE TO SELECTION

Selecting windows that are appropriate for the specific climate in which the building is being built is very important. While every building will be different and may require different levels of performance, there are some simple

rules that can be applied in order to maximise the performance of the building.

As the U-value is a measure of the amount of warmth that is able to pass through the glazing in both directions, the lower the U-value the better the performance of the glazing. Therefore, no matter the location of the building in Australia, a low U-value will always outperform a high U-value.

The SHGC that is best for each building will depend on a number of different considerations including the location and design of the building. SHGCs vary for different climates due to the need to allow or restrict solar gain - which can be beneficial in cold climates and detrimental in hot climates.

In general, for cold climates, such as alpine regions including Melbourne, Canberra and Tasmania, the SHGC should be as high as possible to maximise passive heat gain. This allows free heat from the sun to enter the building thus reducing energy use, especially on northern orientations. It should be noted, however, that while many climates in Australia are predominantly cold, they often experience a number of high temperature days throughout the year and ensuring that the summer sun is not admitted during these times is also important.

For hot climates, such as Brisbane, Darwin and Cairns, that have a high reliance on cooling throughout the year, the aim is to reduce solar admission through low SHGC glazing. This can easily be achieved through the use of tinted products that lower the proportion of heat from the sun that passes into the building.

In mixed climates, such as Sydney, Perth and Adelaide, the SHGC needs to account for both heating and cooling periods. For this reason, an orientation specific strategy is taken. North facing glazing should have a high SHGC to allow passive gains in winter and incorporate shading such as an eave or verandah to block the higher summer sun. Products on the eastern and western façades of a building should incorporate low SHGC to block solar

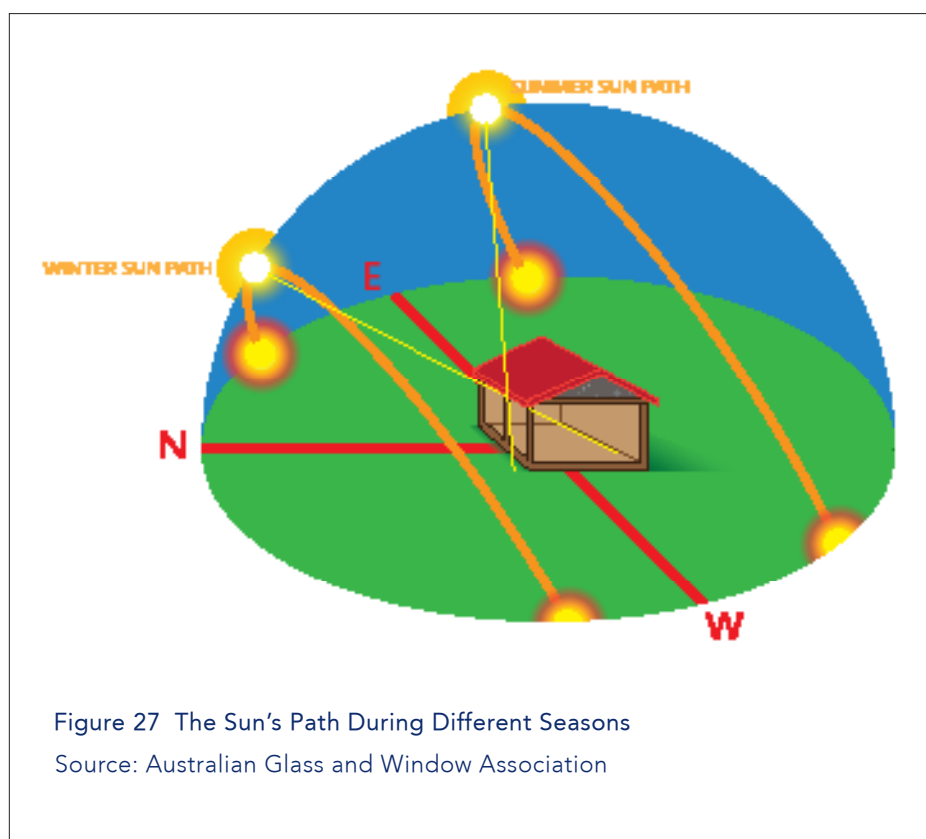


Figure 27 The Sun's Path During Different Seasons  
Source: Australian Glass and Window Association

gain from summer sun as the sun rises and sets.

For the most efficient outcomes, the glazing and building design should be considered together with shading features such as eaves facilitating the shading of the windows when solar gains are not required and allowing them when solar gain is preferential.

---

Further information can be found on the AGWA Guide to Window Selection and the Your Home website.

---

### CONDENSATION ON GLAZING

Condensation on glazing occurs when the surface temperature of the glazing is low and the interior of the room is warm and has high relative humidity. Condensation is complex and is not generally a problem with a window system, but rather is due to the high level of humidity caused by the lack of ventilation in the room or house.

Relative humidity is a function of moisture in the air and temperature; warm air holds more moisture. That means that if the glazing is colder than the surrounding air, the moisture in that air condenses when it comes into contact with the cold surface. If not adequately ventilated, normal living (including tumble dryers, bathrooms, gas heaters and cooking) adds to the relative humidity.

While reducing the sources of humidity within a building and ventilating the space to allow humidity to escape are the easiest methods to reduce condensation, high performance glazing, such as double glazing, and thermally efficient window frames can also help. By increasing the performance of the glazing, the internal temperature can be kept closer to room temperature and therefore above the dew point (when warm humid air condenses into liquid on the surface of the glazing).

The best systems include thermally efficient frames such as timber, uPVC, thermally broken aluminium and composite materials. Glass should also be considered and single pane glass should be avoided as its surface temperature will be much lower than that of an IGU.

---

Further information can be found on the AGWA Key Message on Condensation.

---



Figure 28 Condensation on a Window  
Source: Australian Glass and Window Association

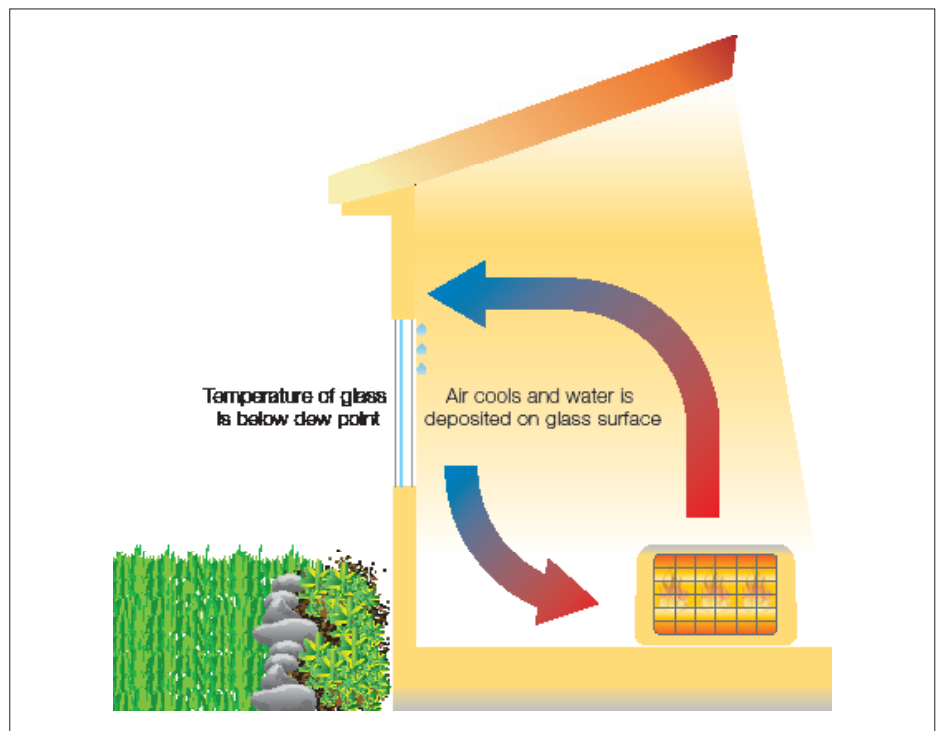


Figure 29 How Condensation Occurs  
Source: Australian Glass and Window Association







# ACOUSTIC GLAZING FOR NOISE ATTENUATION

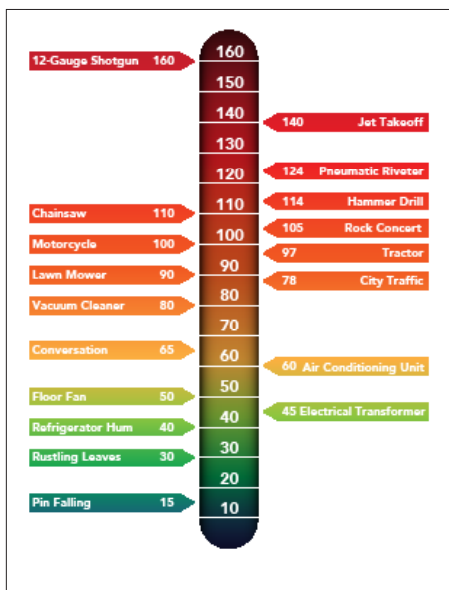


Figure 30 Decibel Scale

Source: Australian Glass and Window Association

Congestion and noise pollution are increasing as development spreads further into the countryside and densities become higher in urban areas. Add to these a general desire among homeowners to get away from it all in their home by blocking out the outside world as much as possible and you see consumers turning more to their windows, which were traditionally overlooked.

The National Construction Code (NCC) requires a level of sound insulation that represents the minimum acceptable building standards, as determined by wide consultation with the community and industry. An owner or designer can always go higher than the NCC requirements if they choose.

It is becoming more commonplace for building designers and homeowners to want to know the acoustic ratings for standard windows and some projects have acoustic specifications written into them now. A significant portion of that interest comes from projects near airports that has boosted interest and demand generally.

When designing or modifying a window, the work must comply with the NCC and consideration should be given to the desired reduction of outside noise. Construction that reduces external noise must be designed to ensure that it is integrated with all other requirements such as energy efficiency.

Improving the sound insulation of windows helps to reduce the level of external noise. The larger the glazed area, the greater the sound transmission through the window. The level of noise reduction will be dependent on the type of glazing that is treated. The noise transfer through and around windows can be reduced by using thicker and/or laminated glazing, a double glazed system and high quality window perimeter seals.

## MEASUREMENT OF SOUND

The decibel (dB) is the unit used to measure the intensity of a sound. The decibel scale is logarithmic; each 10 dB increase in sound corresponds to a perceived doubling of the loudness.

$R_w$  represents the Weighted Sound Reduction Index. This is a single number rating for the insulation property of a window for airborne sound. It is based on an average reduction across a range of frequencies in the audible range (between 100 Hz to 3.159 kHz).

In some cases,  $R_w+C_{tr}$  is specified. The  $C_{tr}$  factor adjusts for low frequency sounds, such as road traffic noise, that are transmitted through materials more readily than higher frequencies. The higher the  $R_w$  value, the better the sound insulation achieved. The  $R_w$  correlates in a general way to decibels of sound reduction.

## REGULATORY REQUIREMENTS

The NCC covers the internal acoustic considerations in Volume 1 for multiple dwellings Class 2, 3 and 9c buildings, but does not provide specific guidance for other building types. In some circumstances, such as near main roads and airports, additional requirements may be required. These are generally covered by Local Government authorities.

**AS/NZS 2107** contains recommendations for the internal sound levels that should be achieved for various rooms based on their intended use. While the standard is not called up in the NCC, it does provide guidance for building designers and planning authorities.

## ACOUSTIC PERFORMANCE OF GLASS

Generally speaking, thicker glass performs better in attenuating noise. However, different glass thicknesses perform differently at different frequencies.

At the lower frequencies, 12 mm glass is much more effective than 6 mm or 4 mm while there is little difference at the higher frequencies. Where the noise problem is traffic and other low frequency noises, a thicker glass will provide the most benefit.

The graph lines in **Figure 31** rise and then suddenly dip. This happens when the glass vibrates in unison with the frequency of the sound. This is called the 'coincidence dip'.

Laminated glass performs slightly better than monolithic glass of the same thickness, especially at higher frequencies. The graph, **Figure 32**, compares 6 mm laminated glass with 6 mm float glass. Note the coincidence dip in the float glass at 2000 Hz compared with a smaller dip for the laminated glass.

Table 2 Acoustic Considerations for Dwellings Source: AS 4055

Environment	Satisfactory	Maximum
Classrooms	35 dB(A)	40 dB(A)
Conference Rooms	30 dB(A)	35 dB(A)
Hotel/Motel Sleeping Rooms	30 dB(A)	35 dB(A)
Residential		
Recreation Areas	30 dB(A)	40 dB(A)
Sleeping Areas	30 dB(A)	35 dB(A)
Work Areas	35 dB(A)	40 dB(A)

Figure 31 Acoustic Performance of Float Glass

Source: Australian Fenestration Training Institute

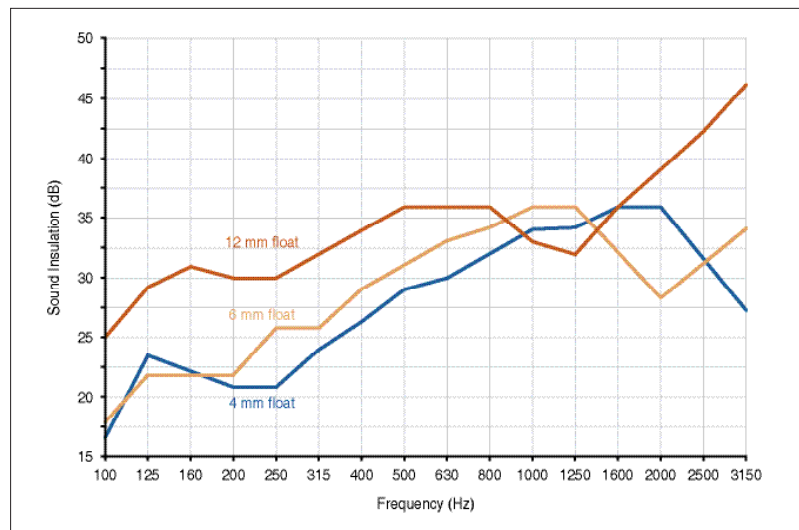


Figure 32 Acoustic Performance of Laminated Glass

Source: Australian Fenestration Training Institute

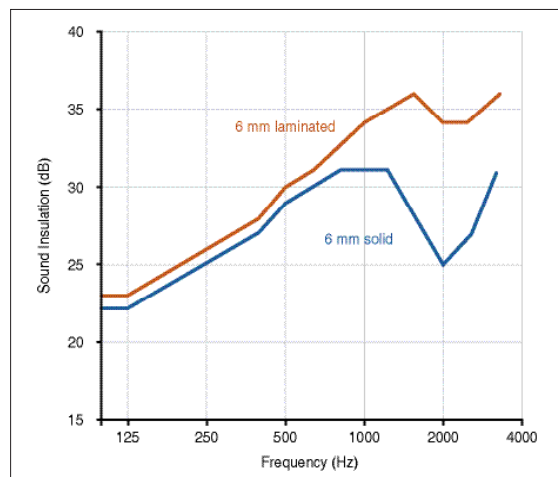




Figure 33 Acoustic Double Glazing  
Source: Capral Aluminium

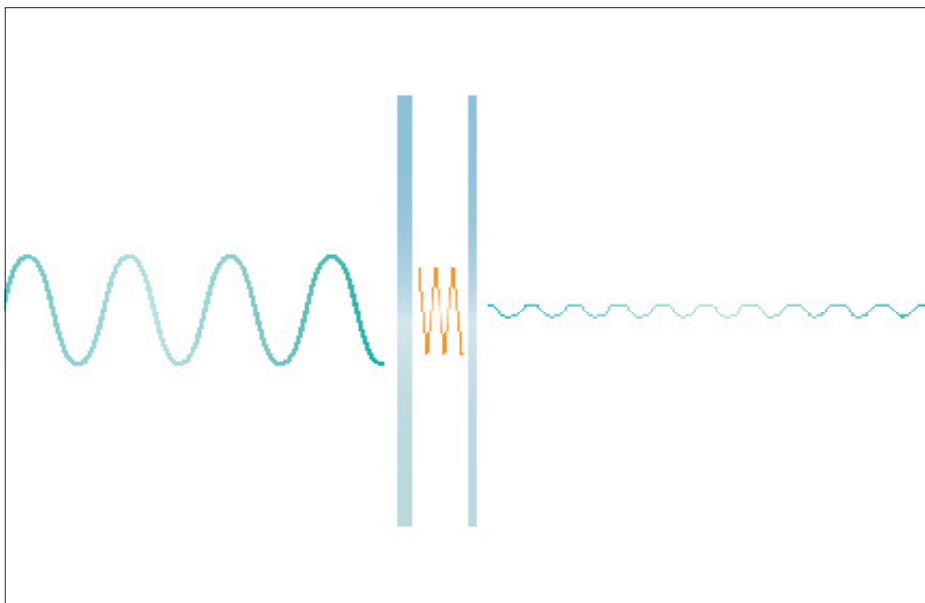


Figure 34 Acoustic Properties of Acoustic Laminate Glass  
Source: Australian Fenestration Training Institute

**HIGH PERFORMANCE SOLUTIONS**

A variety of high performance solutions are available and can be tailored to suit different applications. For specific or high level noise problems, an acoustics engineer can provide a solution. The acoustic engineer assesses the level and types of noise affecting the building and specifies the appropriate acoustic performance requirements.

A common misunderstanding is that double glazing is effective at attenuating noise. However, studies have shown that ordinary double glazing with a standard gap of about 12 mm does not substantially improve the acoustic performance. This gap is too small to provide any real benefit. The most effective solution is to increase the gap between the two panes to at least 100 mm. This is most commonly referred to as secondary glazing, as it often involves two separate window frames.

Another solution is to use two pieces of glass (either in an IGU or Laminate) with each pane a different thickness. For instance, one pane might be 4 mm and the other 6 mm. Each pane in a dissimilar glass unit will attenuate

different sound frequencies. Figure 34 illustrates sound as it travels through the dissimilar glasses. The thicker pane targets lower frequency sounds like a neighbour’s stereo or traffic noise. The thinner pane targets higher frequency sounds like screaming and jet aircraft. This leads to a reduction in amplitude (loudness) across a wider spectrum of frequencies and the result is a significantly higher acoustic rating than for a window with standard glazing. The thicker glass should be about 40 per cent thicker than the thinner glass to have the most benefit.

Recent technological advances in the manufacture of the interlayer of laminated glass have provided an

improvement in acoustic performance. Acoustic laminates have a thicker (0.52 mm or greater) specialised interlayer than is commonly used and provide some improvement over standard laminates. These interlayers are most effective when used with dissimilar glass thicknesses.

**NOISE REDUCTION BY GLASS TYPE**

Table 3 shows the indicative noise reduction for various options compared to 3 mm glass.

Table 3 Noise Reduction by Glass Type

Source: Australian Glass and Window Association

Voice Noise Reduction	%	Traffic Noise Reduction	%
6.38 mm laminated glass	13	6.38 mm laminated glass	24
10 mm glass	24	10 mm glass	38
10.38 mm laminated glass	29	10.38 mm laminated glass	43
4 mm/12 mm gap/6 mm	19	4 mm/12 mm gap/6.38 mm laminated glass	46
10 mm/12 mm gap/6 mm	34	6 mm/100 mm gap/4 mm	57
6.38 mm laminated/8 mm gap/4 mm	46		



# GLAZING IN BUSHFIRE PRONE AREAS

AS 3959 - Construction of Buildings in Bushfire-Prone Areas is primarily concerned with improving the ability of buildings in designated bushfire prone areas to better withstand attack from bushfire, giving a measure of protection to the building occupants as well as to the building itself.

Under the standard, all new homes and renovations are assessed and rated to one of six Bushfire Attack Level (BAL) categories ranging from low to flame zone. The BAL levels are based on heat flux exposure thresholds that measure the amount of energy per square metre of radiant heat exposure. Once the BAL has been determined, specific construction requirements must be followed, ranging from ember protection to direct flame protection.

Glazing is often considered one of the weaker elements of a building. The bushfire standard details glazing requirements for buildings located in a Bushfire Attack Level category greater than BAL-Low.

For some BALs, screening is required to reduce the effects of radiant heat on the glass. Regardless of whether screening is required for radiant heat protection, screening of the openable portions of all windows in all BALs is required to prevent the entry of embers when the window is open. Where screening is required only to prevent the entry of embers, the screening may be fitted internally or externally.

More information can be found in the AGWA Guide to Windows and Doors in Bushfire Prone Areas.

Table 4 Bushfire Attack Levels

Bushfire Attack Level (BAL)	Description of Predicted Bushfire Attack and Levels of Exposure
BAL-Low	There is insufficient risk to warrant specific construction requirements.
BAL-12.5	Ember attack.
BAL-19	Increasing levels of ember attack and burning debris ignited by windborne embers together with increasing heat flux between 12.5 and 19 kWm <sup>2</sup> .
BAL-29	Increasing levels of ember attack and burning debris ignited by windborne embers together with increasing heat flux between 19 and 29 kWm <sup>2</sup> .
BAL-40	Increasing levels of ember attack and burning debris ignited by windborne embers together with increasing heat flux and the increased likelihood of exposure to flames.
BAL-FZ	Direct exposure to flames from fire front in addition to heat flux and ember attack.

**Table 5 Bushfire Attack Level Requirements**  
Source: Australian Glass and Window Association

BAL	Minimum Thickness and Type of Glazing	Frame Material	Screening Requirements
BAL-Low	No specific requirements.		
BAL-12.5	Low-level glazing shall be Grade A safety glass, minimum 4 mm thickness.	<p>Low-level framing must be:</p> <ul style="list-style-type: none"> <li>• Bushfire-resistant timber (Appendix F), or</li> <li>• Timber species as specified in paragraph E2, Appendix E, or</li> <li>• Metal, or</li> <li>• Metal-reinforced uPVC.</li> </ul>	Screens for windows and doors shall have a mesh or perforated sheet with a maximum aperture of 2 mm, made of corrosion-resistant steel, bronze or aluminium.
BAL-19	<p>Low-level glazing shall be toughened glass, minimum 5 mm thickness.</p> <p>Glazing above 400 mm may be annealed, but if so, must be protected by an external screen.</p>	<p>Low-level framing must be:</p> <ul style="list-style-type: none"> <li>• Bushfire-resistant timber (Appendix F), or</li> <li>• Timber species as specified in paragraph E2, Appendix E, or</li> <li>• Metal, or</li> <li>• Metal-reinforced uPVC.</li> </ul>	Screens for windows and doors shall have a mesh or perforated sheet with a maximum aperture of 2 mm, made of corrosion-resistant steel, bronze or aluminium.
BAL-29	<p>Windows: Glazing shall be toughened glass of a minimum 5 mm thickness. Low-level glazing must be protected by an external screen.</p> <p>Hinged Doors: Glazing shall be toughened glass of a minimum 6 mm thickness. Low-level glazing must be protected by an external screen.</p> <p>Sliding Doors: Glazing shall be toughened glass of a minimum 6 mm thickness.</p>	<p>All framing must be:</p> <ul style="list-style-type: none"> <li>• Bushfire-resistant timber (Appendix F), or</li> <li>• Metal, or</li> <li>• Metal-reinforced uPVC.</li> </ul>	Screens for windows and doors shall have a mesh or perforated sheet with a maximum aperture of 2 mm, made of corrosion-resistant steel, bronze or aluminium.
BAL-40	<p>Windows: Glazing shall be toughened glass of a minimum 5 mm thickness. Low-level glazing must be protected by an external screen.</p> <p>Hinged Doors: Glazing shall be toughened glass of a minimum 6 mm thickness. Low-level glazing must be protected by an external screen.</p> <p>Sliding Doors: Glazing shall be toughened glass of a minimum 6 mm thickness. All glazing must be protected by an external screen.</p>	All framing must be metal.	Screens for windows and doors shall have a mesh or perforated sheet with a maximum aperture of 2 mm, made of corrosion-resistant steel or bronze. Aluminium mesh cannot be used.
BAL-FZ	Glazing system (including frame, glass and screening) must be tested to AS 1530.8.2.		

**NOTE:** Where double-glazed units are used, the glazing requirements provided in this standard apply to the external face of the window assembly only.

Low-level glazing is any glass within 400 mm of the ground, decks, carport roofs, awnings or similar horizontal (or near horizontal) elements.

#### BAL TESTING

Systems tested to AS 1530.8.1 may be used for all levels up to and inclusive of the BAL level achieved. Systems tested to AS 1530.8.2 may be used for all BAL levels. Even if any material, element of construction or system satisfies the test criteria without screening for ember protection, screening of openable parts of windows or doors is still required.







# GLASS INSTALLATION

## SAFE HANDLING OF GLASS

Glass can be a dangerous material if handled incorrectly. The most significant risk of injury associated with glass handling is through cuts and piercing injuries. Cut edges can be extremely sharp and broken glass can form razor-sharp pointed and jagged shards. Personal protective equipment (PPE) and safe handling methods must be employed for safety and well-being.

Personal protective equipment includes; approved glass gloves, forearm gauntlets, safety glasses and sturdy work boots as a minimum. Additionally, it is important to wear the appropriate clothing when handling glass. Ideally, clothing should be full length, of sturdy construction and be tight fitting.

Glass should be handled with care at all times. As it is usually transparent, care must be taken when walking around or near areas where glass is stored or being handled. Work areas should be marked out with flags, signage or other appropriate means to ensure people don't unknowingly approach.

Ideally, suckers should be used for lifting glass to avoid possible injury from the glass edge. A proper lifting technique must be used so that glass is lifted close to the body using legs rather than the back. Glass should never be lifted above shoulder height and extra care must be taken when working from an elevated platform.

Before handling glass, it should be inspected for any possible starts or runs, as these can lead to sudden breakage during handling, greatly increasing the likelihood of injury.



Figure 35 Glass Suckers  
Source: Shutterstock



Figure 36 Glass Storage Racks  
Source: Shutterstock



Figure 37 PPE for Glass Handling  
Source: Work Cover NSW

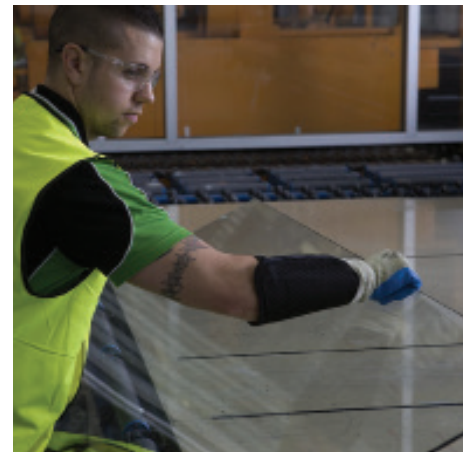


Figure 38 Glass Handling Procedures  
Source: Shutterstock (top),  
Viridian (bottom)

## PREPARATION AND PLANNING

Surfaces must be clean, dry and, if necessary, primed in accordance with the manufacturer's instructions prior to installation of the glass. Ambient temperatures must be within the manufacturer's specified range during both the time of application and cure.

The compatibility of materials is essential to the long-term performance of any glazing installation. Chemical reactions from physical contact or close proximity exposure to incompatible materials can occur. Sealants and gaskets installed in glazing areas must be compatible with the fabricated product as well as with the other materials used in the glazing operation. These materials include:

- Glazing sealant
- Gaskets
- Glazing tapes
- Wedges and channels
- Insulating glass sealants
- Interlayers
- Setting blocks
- Structural silicone sealant
- Applied films
- Cleaning materials
- Sash joinery sealant
- Timber preservative treatments

## SEALANTS

A sealant is a flexible material which, when applied between two or more parts of a structure, prevents elements like air, moisture, water and dust from penetrating the joint due to its adhesive qualities.

Sealants are a primary defence against water penetration and air infiltration in building façades. Performance problems result from inappropriate sealant selection, improper joint design or sealant installation, inherent problems in the sealant, or aging deterioration. A general understanding of how different sealants are used, and the signs of deterioration and failure, is useful in recognising a problem condition before more damage occurs.

One of the basic and most important characteristics of any joint sealant is its adhesion. Adhesion is the ability

of a sealant to stick to the interface of the joint. Hence, a sealant should exhibit good adhesive qualities without either chemically attacking or reacting to the contact surfaces of the joint. Adhesion can be achieved by the use of a natural adhesive base polymer or adhesive promoters incorporated in the compound. This may be supplemented at the time of application by using special prime coats or surface conditioners. Obviously, the use of base polymers with inherent adhesion is preferred as they lend themselves to ease of application and enhance the life span of the product.

It is essential that the seal be absolutely water-tight when subjected to heavy rains associated with high wind velocities. Normal penetration of rain through walls is easily detected, as there is a general flooding of sills, walls and floors with attendant staining and damage to finishes. Partial rain penetration is seldom recognised but has latent effects. It can cause the deterioration, and accelerated failure, of factory sealed IGUs and possible glass breakage due to the corrosion of the surrounding framework.

The sealant material should be resilient under all weather conditions. It should have good weathering properties and a low permanent set. This is to facilitate joint movement (with no adverse consequences) and yet still enable the glass or panels to freely float. The weathering qualities should not produce shrinkage or creep in the sealant.

In some geographical locations, the temperature can range from -4 °C to 55 °C, producing a large temperature differential. This results in thermal expansion of both the glass and the frame surrounding it. Due to the difference in the coefficient of thermal expansion relative movement can occur. This movement can develop shear, compressive and tensile stresses that have to be absorbed by the sealant material.

Large glazed window areas (especially the body tinted and reflective glass range) produce thermal stresses on their edges when subject to solar radiation. These stresses, in conjunction

with that contributed by the framing material, have to be absorbed by the sealant without undue and adverse effect on the whole glazing system.

Surface preparation is critical to sealant adhesion and long-term success of the joint. It is even more critical for structural glazing as, if the sealant does not stick, the results can be disastrous. Although sealant application seems easy, it is critical to apply the sealant correctly. The steps to correctly apply sealant are:

1. The sealant must be applied immediately after cleaning/priming. Wait too long and dust will collect and contaminate the frames. This is critical for site work or industrial environments.
2. The sealant is applied by pushing a bead of sealant forward into the joint cavity. Pulling the gun is not recommended as the sealant tends to get laid over the joint rather than pushed into it.
3. Completely fill the joint.
4. Tool immediately.

## DRY GLAZING

Dry glazing typically has two forms, channel and wedge.

Channel glazing, sometimes referred to as wrap-around glazing, is a method of glazing that is common in residential window and door systems, such as sliding patio doors, and sashes in sliding, awning and double hung windows with monolithic glass. It is not commonly used with IGUs due to the tendency for the rubber channel to hold moisture which may cause deterioration and premature failure of the sealed IGU.

An extruded PVC or synthetic rubber U-channel is wrapped around the edges of the glass and usually joined at the top centre of the glass. The corners are partly slit to make the 90 degree turn. The extruded aluminium frame members are then forced onto the channel and screwed together at the corners. The advantage of this system is that it is fast, effective and the framed light is then ready to be installed into the outer frame.

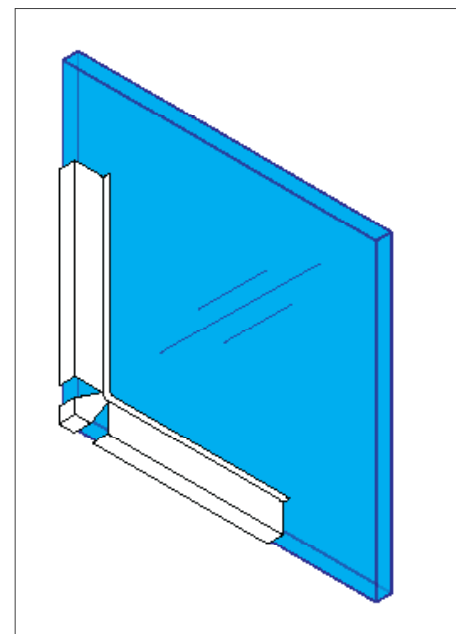
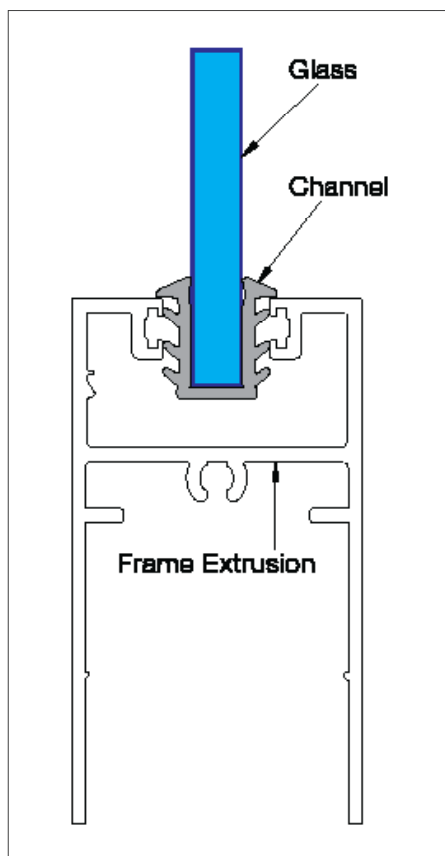


Figure 39 Channel Glazing  
Source: Australian Glass and Window Association

The integrity of the glazing is highly dependent on the correct sizing of the glazing channel. Consideration must be given to the thickness of glass and the aperture of the framing system to ensure the correct sized channels are fitted to achieve adequate, but not excessive compression.

Extruded channels, depending on the type of material, may shrink, so when being fitted, careful attention must be paid to avoid stretching.

Common in both residential and commercial applications, wedge glazing utilises extruded PVC, EDM or synthetic rubber wedges as one or both of the glazing seals.

A basic rubber wedge is fitted on one or both sides of the glass in order to secure the glass in place. The soft material of the wedge will compress 25 to 40 percent and form a weather tight seal. Different glazing systems may use only a single type of wedge for both sides of the glass or may use a combination of two different sizes or types of wedge.

Wedges need to be properly retained in the framing system and this can be achieved in a number of ways. Some wedge systems use an integral dart, a locking nub or an adhesive material to prevent disengagement.

Captive wedges are often used on one side (typically the inside) and feature a co-extruded backing which is inserted into a T-slot in the frame. Captive wedges are therefore retained in the frame and cannot easily be removed without some degree of disassembly.

When using wedges with an integral dart or locking nub, it is important that the wedge design is compatible with the framing system so that they properly locate and engage with the corresponding lip of the framing system. It is highly recommended to check with the wedge and frame manufacturers to verify fit and tolerances.

Careful sizing of the wedges is extremely important and proper

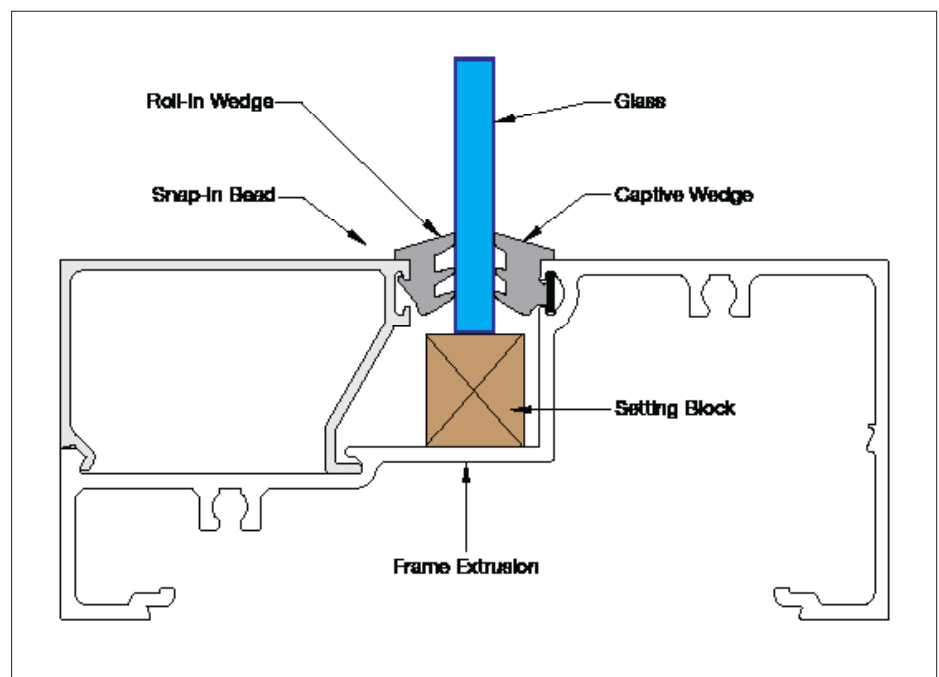
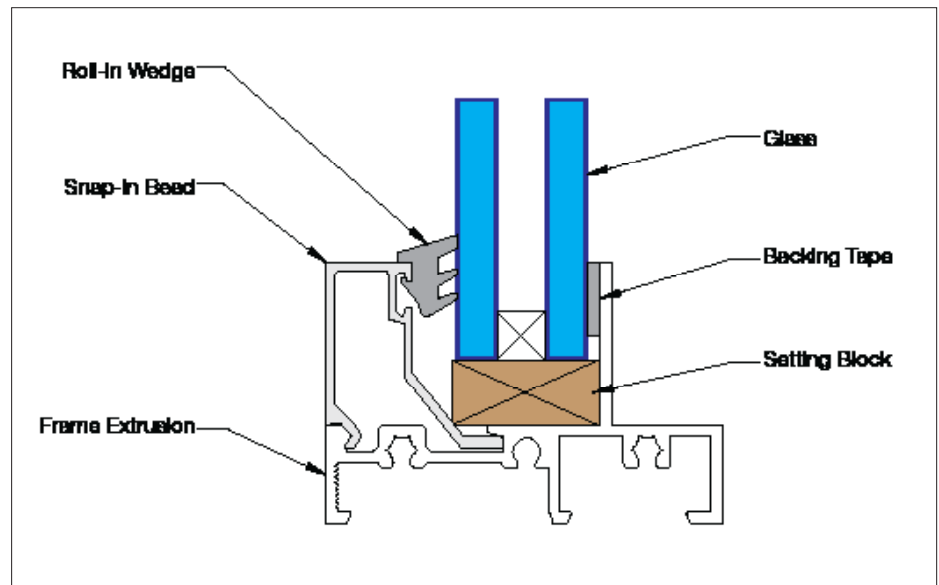


Figure 40 Wedge Glazing

Source: Australian Glass and Window Association

consideration must be given to the thickness of the glass to ensure that appropriate sized wedges are fitted for the framing system.

Wedges should always be fabricated or cut slightly longer than the opening they are to fit (known as crowding). This is to account for the natural relaxing of the material that can occur after installation. Some wedges, depending on the type of material, may shrink. Consult the gasket manufacturer

for shrink rates, if applicable, and guidelines on gasket sizing (crowd factor).

Installation of the wedge should begin from two adjacent corners of the opening and roughly 100 mm of the wedge should be pressed into place at each corner. Next, around 100 mm of the wedge at its centre should be pressed into place at the midpoint between corners. If the opening dimension is large, repeat the process

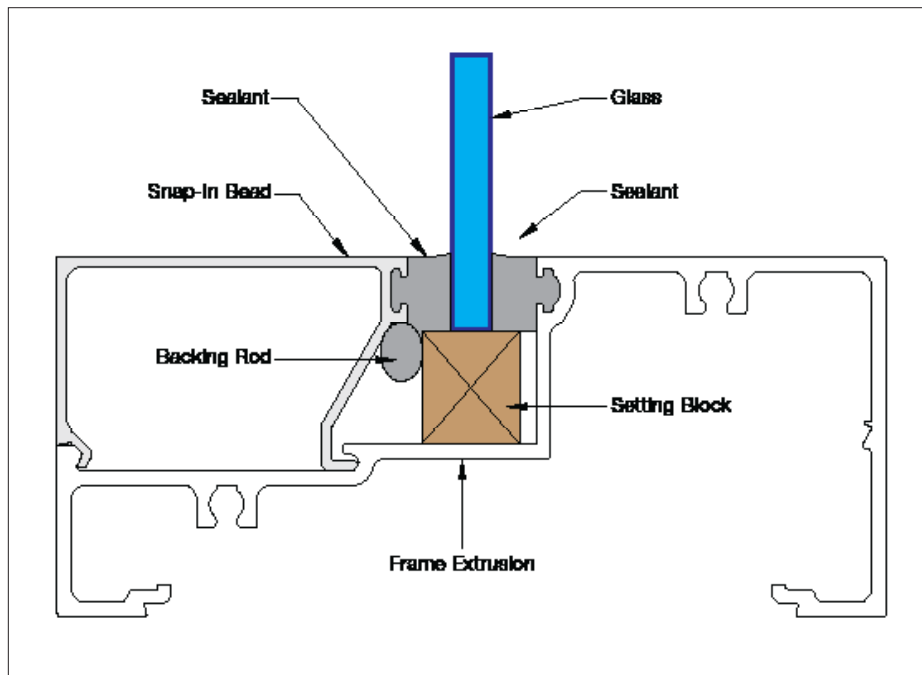


Figure 41 Wet Glazing  
Source: Australian Glass and Window Association

at the quarter points. The balance of the gasket is then inserted, working from the two already inserted points toward each other. This procedure distributes the excess of the gasket equally and will remove any tendency to stretch the wedge.

### WET GLAZING

Wet glazing sealants are materials such as polysulphides, silicones, urethanes, acrylics and other synthetic polymers. They cure to a resilient state by chemical reaction with external forces, such as temperature and humidity, or by solvent release. They should be used as a gunned-in-place glazing sealant or as a cap bead. Surfaces must be clean, dry and, if necessary, primed in accordance with the manufacturer's instructions. Ambient temperatures must be within the manufacturer's specified range during the time of application and cure.

Wet glazing sealants are generally classified as either structural or non-structural. Structural sealants are used when the sealant itself is the primary means of securing the glass in place as it adheres the glass to the supporting framing members. Where mechanical

fixings are used, non-structural sealants may be used.

### BUTT-JOINT GLAZING

Butt-joint glazing is a method of installing glass to provide wide horizontal areas of vision without the interruption of vertical framing members. It utilises a number of individual glass panes that are conventionally glazed at the head and sill, using wet or dry glazing methods, to form a continuous span of glazing with vertical glass-to-glass joints. The adjoining vertical glass edges are spaced slightly apart and sealed with a silicone sealant. The sealant serves only as a weather stop at the vertical joints; therefore, this vertical glass and sealant joint are not structural.

The design and execution of satisfactory butt-joint glazing requires more attention to detail at every stage than does a conventional system with vertical framing members. The glass is supported on only two edges (usually head and sill) and therefore design load charts for four-edge support are not valid. Glass deflection and stress under design load will be substantially greater

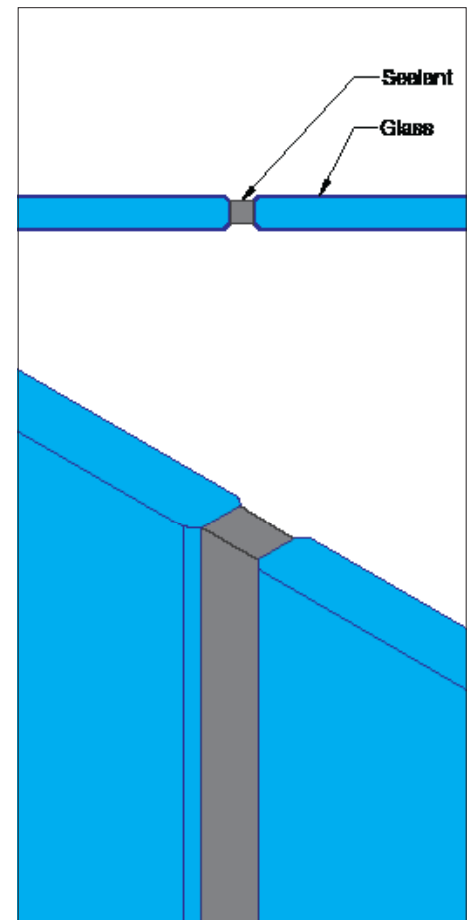


Figure 42 Butt-Joint Glazing  
Source: Australian Glass and Window Association

for two-edge supported glass than glass of the same thickness and size supported on four edges.

Precise levelling of the sill is important and provision must be made at the head for deflection of the structure. The vertical glass edges must be ground with a slight arriss and should also be polished for the most acceptable finish.

Insulating glass units are not suitable for butt-joint glazing because when the glass deflects, the sealants are placed in extreme shear along the unsupported edge between the glass and spacer. Typically, insulating glass manufacturers do not warrant their products in this application.

Glass and sealant manufacturers' recommendations for edge treatment, specific sealant, use of primers and construction (sealing) of the butt-joint must be followed exactly.

## STRUCTURAL SILICONE GLAZING

Structural silicone glazing is not to be confused with butt-joint glazing or wet glazing. Structural silicone glazing systems utilise structural silicone sealant as the means of attachment for support of one or more edges of the glass and requires special considerations. Continual close attention must be given to all details of the installation.

Only certain silicone sealants can be used or are generally approved by the sealant industry for structural applications. Joint size should be designed for structural loads. Consultation and cooperation with the sealant supplier is critical.

The structural sealant must be tested for compatibility with all other sealants or accessory materials (gaskets, spacers, backer rods, weather seal, setting blocks, metal finishes, glass coatings, etc.) that the structural sealant will contact.

The structural silicone sealant must be tested for adhesion with the substrates that it must adhere to on a project specific basis. The surface preparation and sealant application procedures (solvent cleaning, priming, masking, cure time, etc.) supplied by the structural silicone supplier must be followed fully. Failure to properly prepare the structural surfaces or to properly apply the structural sealant

can result in premature failure of the structural sealant.

IGUs used in structural silicone glazing applications must be fabricated with a structural silicone secondary sealant. Polysulphide, polyurethane or hot melt butyl should not be used in this application. The insulating glass fabricator must be advised that the units are to be used in a structural silicone application and should review and approve the glazing details on the shop drawings.

## SETTING BLOCKS

Glass should be set on two identical neoprene, EPDM, silicone or other compatible elastomeric setting blocks having a Shore A Durometer hardness of  $85 \pm 5$ . The preferred location is centred at the quarter points of the sill supporting frame. In some cases, it may be necessary and/or acceptable to move the setting blocks equally toward the corners of the light as far as the one-eighth points.

Locating the setting blocks less than 150 mm from the corner of the glass may introduce additional stresses to the glass and to the insulating glass seals. The proper sizing and design of the setting blocks ensures the glass bears fully on them, yet allows water passage to the weep holes. The width of the setting blocks should be at least 3 mm wider than the glass thickness.

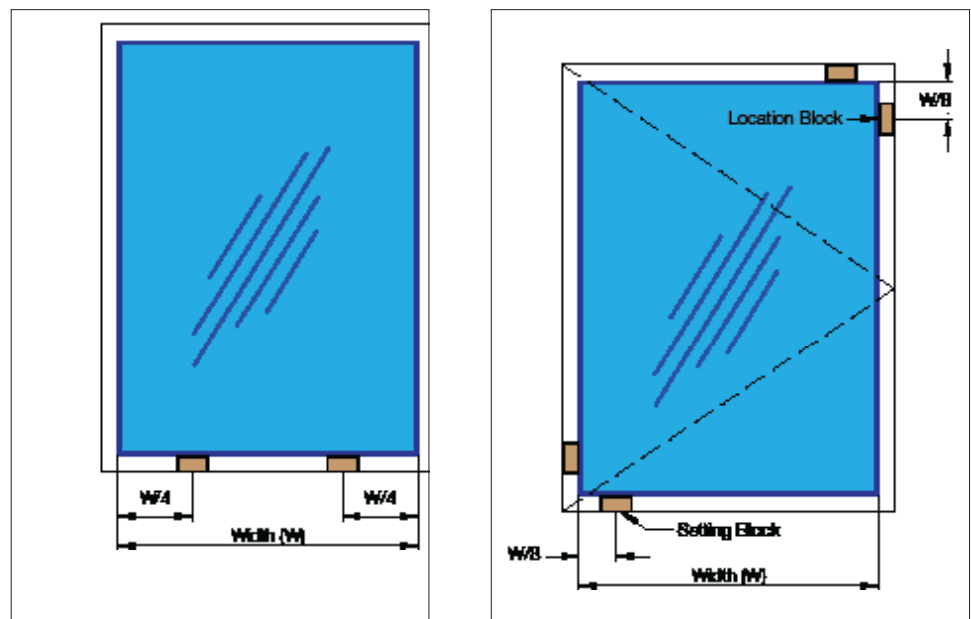
Edge blocking for casement windows and doors is a common practice and can be acceptable as long as the glass edges are not excessively loaded. Excessive pressure on the glass edge can lead to glass breakage or seal failure due to pressure points and mechanical bending stresses imposed upon the glass (for example, frame movement during operation).

This can also impair the sealant performance if the pressure is such that the glass movement occurs in a magnitude sufficient to shear or distort the sealants. An allowable load on the edge of insulating glass used for casement windows and doors would be that for each block the load applied is less than half of the total glass weight of the insulating glass unit.

The design of the frames for casement windows and doors should ensure that the frame is supporting the glass and the glass is not supporting the frame. The use of blocking prevents impact of the glass edges against the frame during movement of the frame supporting the glass and keeps the glass properly positioned within the glazing system.

Figure 43 Setting Blocks

Source: Australian Glass and Window Association





## LAMINATED GLAZING MATERIALS

Laminated glazing materials must be installed in a glazing system that incorporates a drainage system as it is essential that the edges of the glass remain dry and are not exposed to water vapour for extended periods of time. Prolonged exposure to solvents, solvent vapours (including that of acetoxysilicones), water or water vapour can cause delamination or haziness around the edges.

Laminated glass is generally not recommended for butt-joint or structural silicone glazing systems. In all laminated glass installations, sealant compatibility with the interlayer material should be checked prior to glazing. Recommended sealants include polysulphides, silicones, butyl, polybutylene tapes and polyurethane.

## INSULATING GLASS UNITS

Prolonged exposure to water or water vapour can cause failure of the edge seal of an IGU and it is therefore important that glazing systems incorporate adequate drainage. Glazing materials must be compatible with the edge seal of the IGU to prevent chemical reaction and decomposition of the seal. Many glazing systems apply pressure to the edge of the glass to achieve a weather tight seal. Excessive pressure can increase mechanical stresses, distortion and possibly cause glass breakage.

AS/NZS 4666 describes several fundamental principles for the correct glazing of IGUs. Compliance with AS/NZS 4666 requires that:

- Installation of IGUs must prevent the edge seal of the unit being in prolonged contact with moisture. If water is trapped against the edge seal of a unit for a long period it may result in failure of the adhesive bond between the sealant and the glass allowing moisture (water, water vapour or both) to penetrate the edge seal leading to condensation on the glass surface within the cavity.
- The edge seal of the IGU must be protected from the adverse effects of weathering and solar radiation.

The edge seal on most units can degrade if exposed to the sun or ultra-violet light. It is important to ensure that rebates and frame systems fully cover and adequately protect the edge seal. The two most common edge seal types are Polysulphide and Silicone. Polysulphide is used by most manufacturers but is more vulnerable to UV breakdown if left exposed. It is therefore recommended that Silicone seals are used where edge seals may be exposed.

- Materials used in the installation of IGUs must be compatible with the edge seal.

The compatibility of materials is essential to the long-term performance of any glazing installation. Chemical reactions from physical contact or close proximity exposure to incompatible materials can occur. Sealants and gaskets installed in glazing areas must be compatible with the fabricated product as well as with the other materials used in the glazing operation. A list of compatible sealants should be available from the IGU supplier. These materials include:

- Glazing sealant
- Gaskets
- Glazing tapes
- Wedges and channels
- Insulating glass sealants
- Interlayers
- Setting blocks
- Structural silicone sealant
- Applied films
- Cleaning materials
- Sash joinery sealant
- Timber preservative treatments

## INSTALLATION OF GLASS

1. Temperature conditions during glazing must be within the limits required by the sealant and gasket manufacturer(s).
2. Measure glass for proper dimensions.
3. Ensure the glass edges are free of damage (chips, shells, starts, etc.) and that the cut edge quality

is good. Glass with poor edge condition can lead to stress cracking and failure, even after the window has been in service. Glass with questionable edge conditions should be set aside for inspection by the glass manufacturer or fabricator. Refer to the Defects in Glass chapter on page 58.

4. Do not impact the glass against the framing during installation. This can cause edge damage. Pocket, or 'Flush Glazing', is particularly susceptible to glass edge damage from impacting the frame and requires precise sizing of the glass and extra care during installation.
5. Always use suction cups to shift a light of glass within the opening. Raising or drifting the glass with a pry bar can cause edge damage.
6. Some insulating and laminated glass fabricators place temporary glazing instruction labels on their product such as 'Glaze This Side In' and/or 'Glaze This Edge Up'. It is important field supervision instruct installers to adhere to these instructions. Some products are provided with specific performance characteristics (energy, security) that will not perform appropriately if not properly installed.
7. When the glass is located in place, sufficient pressure must be placed against the glass as it is lowered onto the setting blocks to properly place the gasket, sealant or tape under pressure or compression. Uneven or point pressures on glass can result from improper positioning of the glass on the setting blocks, which can in turn result in insufficient weather seal and/or glass breakage.



# GLASS CUTTING AND PROCESSING



Figure 44 Hand Cutting Glass  
Source: Shutterstock

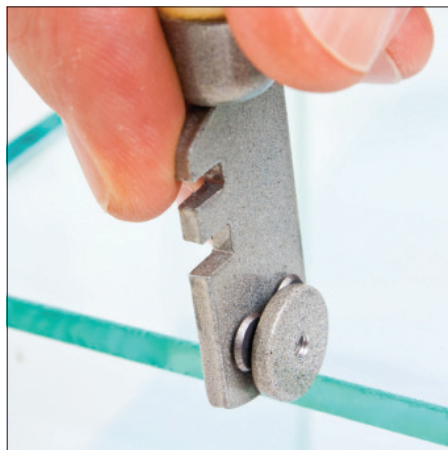


Figure 45 Glass Cutting Tool  
Source: Shutterstock

Most flat glass used in the building industry is cut with a cutting wheel, made of tungsten carbide or polycrystalline diamond and with a V-shaped profile, which is pressed firmly against the surface of the glass and a line is briskly scribed to form a 'score' or 'cut'. The scoring makes a split in the surface of the glass which encourages the glass to break along the score.

Regular, annealed glass can be broken apart this way but not tempered glass as it tends to shatter rather than breaking cleanly into two pieces. Laminated glass can be cut using the same process, however, as the glass consists of two individual pieces, laminated glass must be scored on both sides.

Glass processing includes edgework, holes and cut-outs. Edgework usually occurs where one or more edges of the glazing are exposed (to remove the sharp edges of clean cut glass and also for decorative purposes).

Table 6 Glass edge Types and Applications

Source: Australian Glass and Window Association

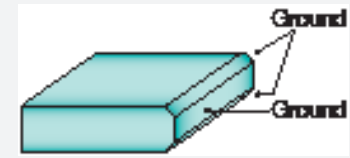
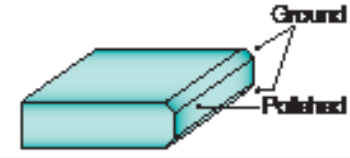
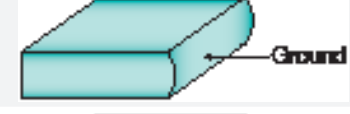
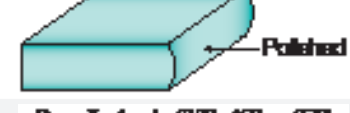
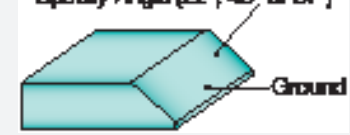
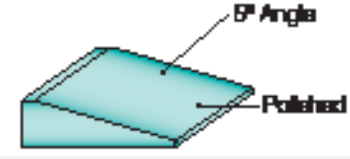
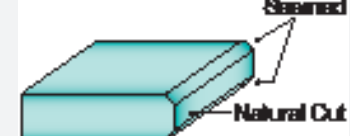
Edge Diagram	Description	Typical Application
	Flat Ground	Silicone structural glazing with exposed edges
	Flat Polish	Silicone structural glazing where edge condition is critical for aesthetic purposes
	Ground Pencil Edge	Mirrors, decorative furniture glass
	Polished Pencil Edge	Mirrors, decorative furniture glass
	Ground Mitre	Silicone structural glazing
	Bevel	Mirrors, decorative furniture glass
	Seamed Edges	Normal edge treatment for heat-treated glass

Figure 46 Glass Processing Machine: FOREL Vertical Edging Machine. Source: Overseas Glass Agencies

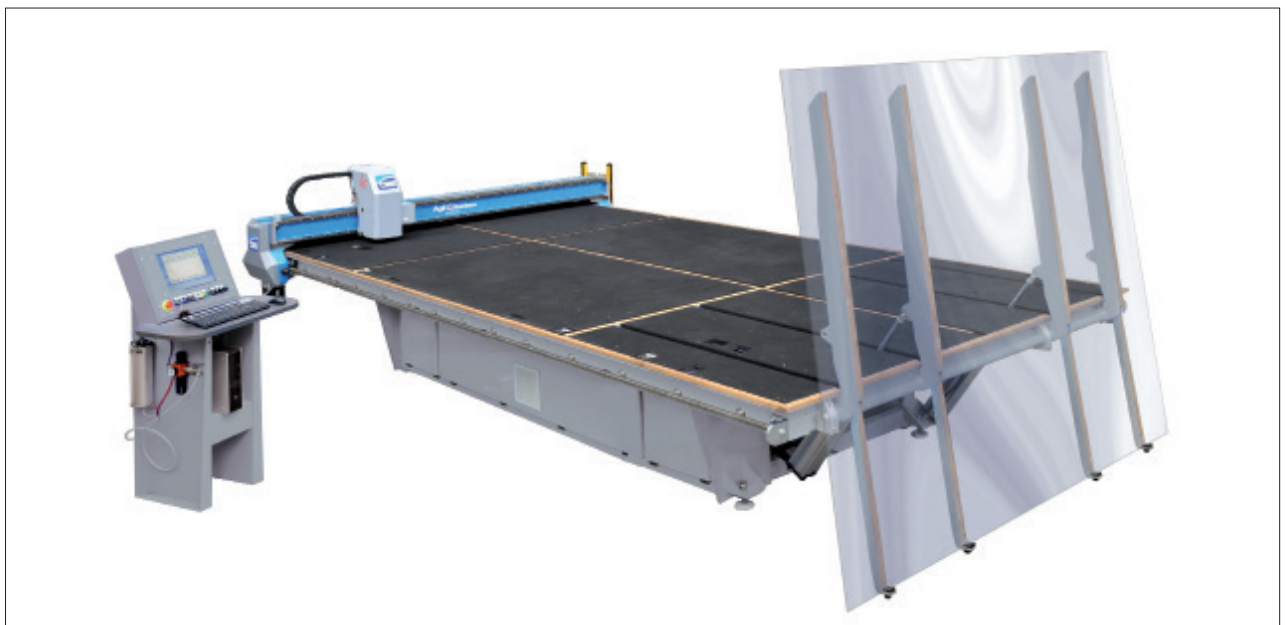


Figure 47 Glass Processing Machine: CMS Futura P Glass Flat Wire Grinding Machine  
A double straight edging machine with automatic loading and unloading systems, plus automatic paper interleaver.  
Source: SCM Group Australia



Figure 48 Glass Processing Machine: CMS AGIL Glass Cutting Table  
A fixed cutting table with loading arms, two interpolated axes and a pivoting head for cutting panes of straight and shaped flat glass.  
Source: SCM Group Australia

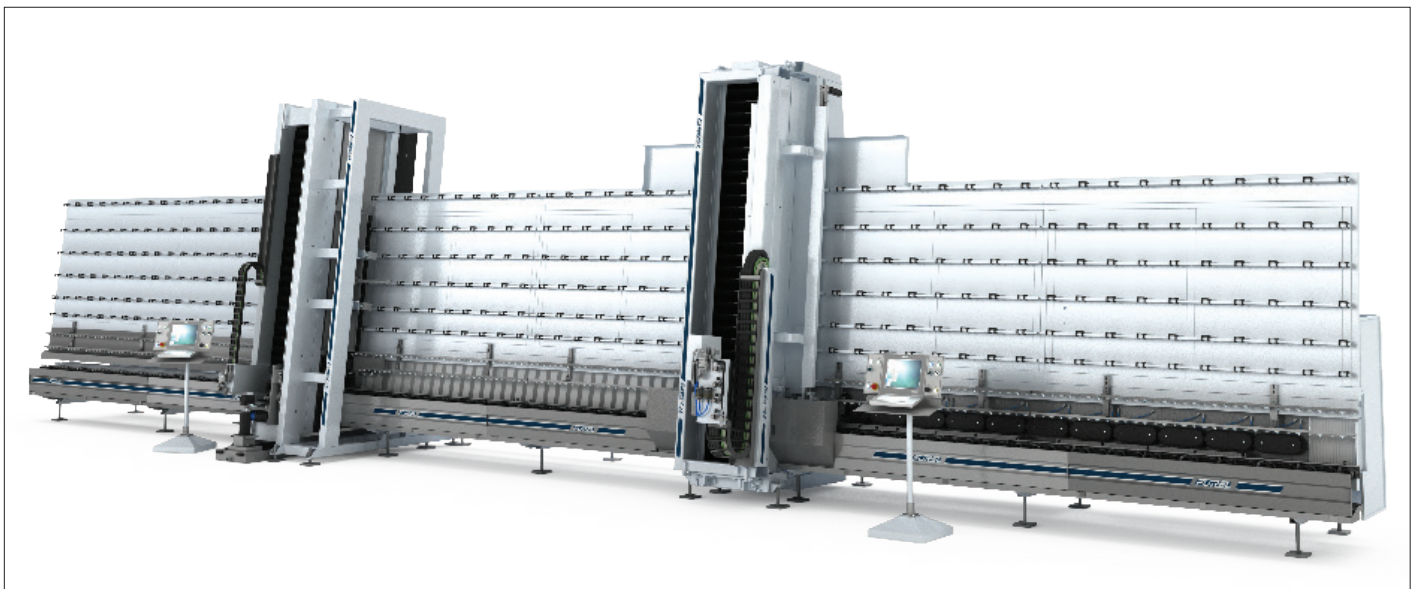


Figure 49 Glass Cutting  
Source: SCM  
Group Australia

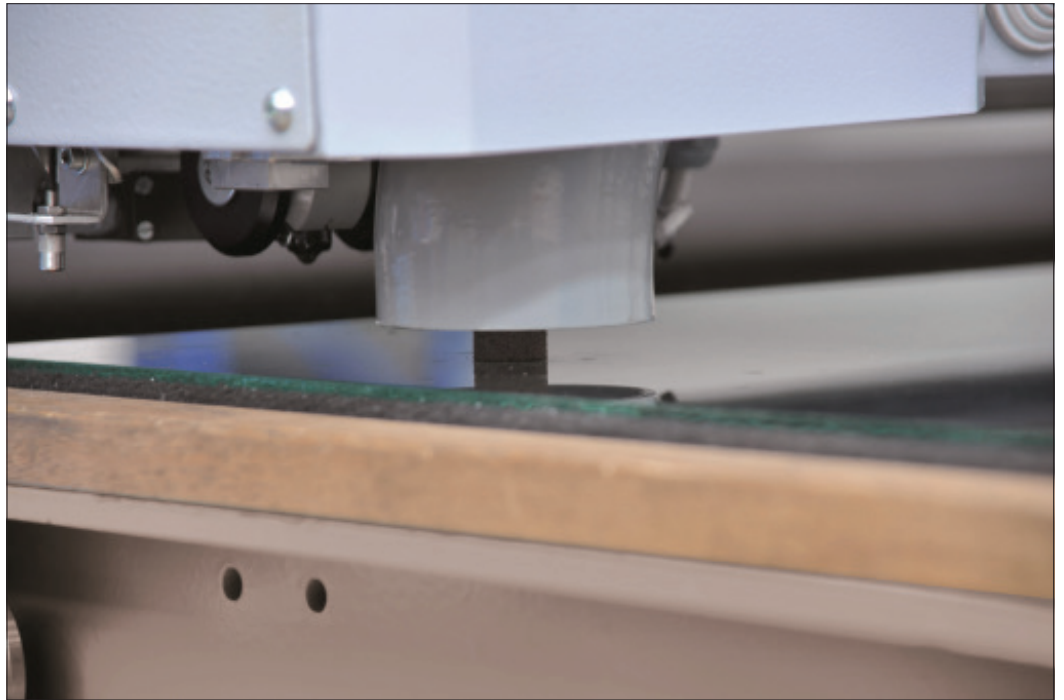


Figure 50 Glass Cutting  
Source: SCM  
Group Australia

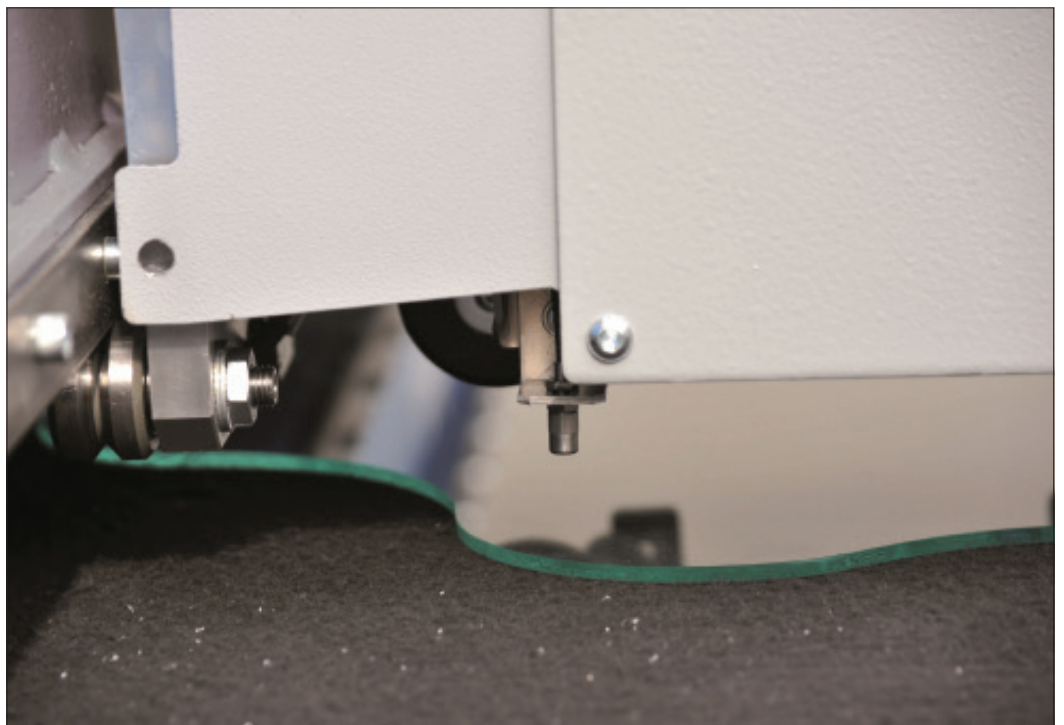
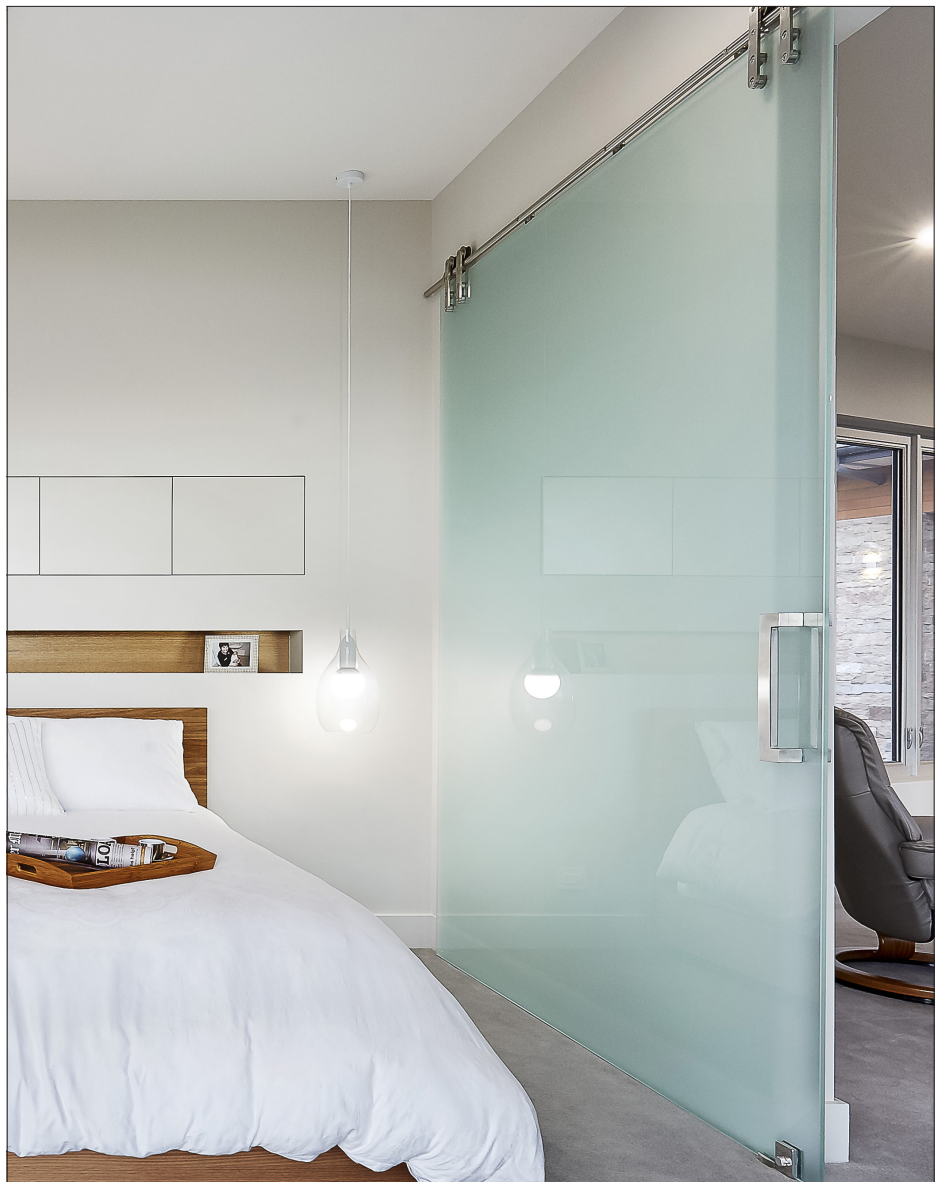


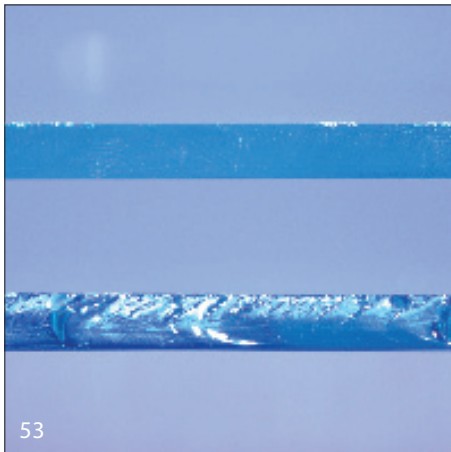
Figure 51 Edgework and Cut Outs in a Shower Screen  
Source: Viridian



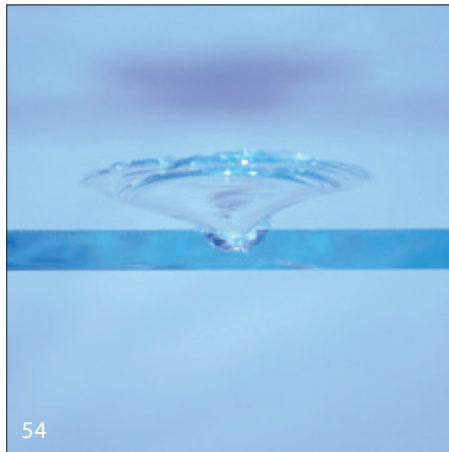
Figure 52 Glass Cut Outs Allow Affixed Hardware on an Internal Sliding Door  
Source: DLG Aluminium & Glazing



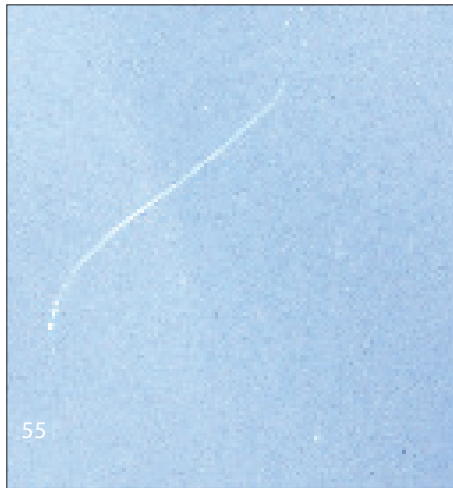
# DEFECTS IN GLASS



53



54



55

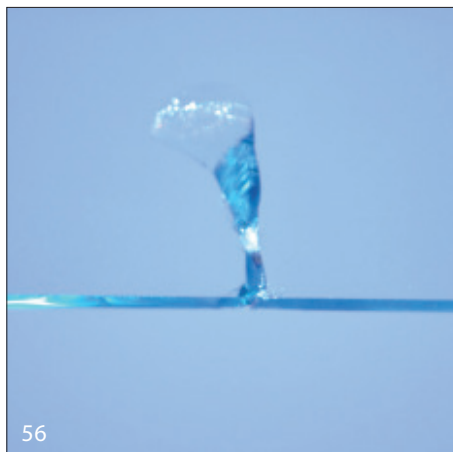
Figure 53 Edge Condition: Feathering  
Source: AGWA

Figure 54 Edge Condition: Shell  
Source: AGWA

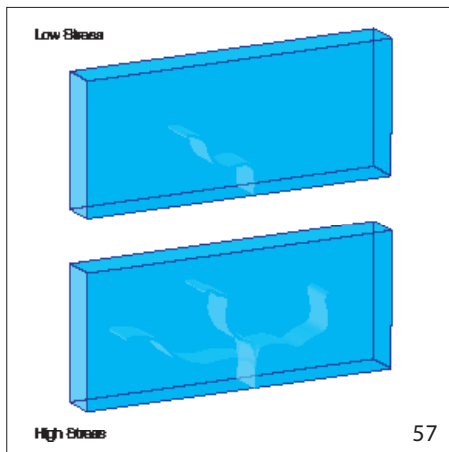
Figure 55 Scratches on Glass  
Source: AGWA

Figure 56 Starts and Runs in Glass  
Source: AGWA

Figure 57 How Runs Propagate Through Glass Under Stress  
Source: AGWA



56



57

## FEATHERING

The quality of glass cut edges is the single most important factor affecting the edge strength of glass. Poor cut-edge quality can reduce glass edge strength which makes the glass particularly vulnerable to fracturing under thermal loading.

When glass is cut, the edges are sharp. Minor distortions, called feathering, are normal, however, severe feathering and edge vents will weaken the overall strength of the glass and may cause failure. Glass with poor quality cut edges may appear to be stable, however, the small imperfections provide a weak-point when the glass is under load.

## SHELLS

Shells are a common form of edge damage and are usually the result of impact. Very minor edge damage is acceptable, however, shells bigger than 50 per cent of the glass thickness are considered defective as they will weaken the glass and may cause failure.

## SCRATCHES

Surface scratches in glass are without doubt the most common problem. Glass must be handled carefully and rubbing during transport avoided. When loading and unloading racks, corners and edges must not come into contact with the face of other panes to avoid scratching.

## STARTS AND RUNS

A start is a small crack in the glass, often nearly invisible except on close inspection, that usually results from some sort of edge defect such as a shell or severe feathering. Once a crack is started, it will almost always 'run' (get bigger) through the glass.



# NICKEL SULPHIDE AND HEAT SOAKING OF TOUGHENED GLASS

The use of toughened and some heat strengthened glass may involve a relatively small risk of breakage resulting from nickel sulphide inclusions.

Nickel sulphide is a material that can form in several crystallised states and only one of these states is stable at room temperature. During the melting process for the manufacture of float glass, a small level of nickel contamination can be expected to occur from the raw materials. These small nickel inclusions are converted during the melting operation into a nickel sulphide crystal.

During the flotation and annealing process, the glass temperature can drop from 1100 °C to room temperature in 20 minutes. However, a nickel sulphide fault can typically take two to three years before it is converted to stable state. During the conversion, the nickel sulphide increases its volume by approximately 4 per cent, putting high stresses into the glass near the inclusion. These stresses can generate stress cracks causing spontaneous fracture of the glass.

The most serious consequences of such a failure is for external glazing, where shattered glass could fall onto a pathway or pedestrians below. There have been incidences of this both in Australia and overseas.

Sloped overhead glazed assemblies more than three metres above floor or ground level and all vertical glazed assemblies more than five metres above floor or ground level must incorporate measures to reduce the risk of breakages due to nickel sulphide inclusions. Toughened safety glass must be heat soaked or suitably protected by a balcony, awning or the like so that in the event of glass breakage, the risk of injury to people or property damage is minimised.

To reduce the likelihood of spontaneous breakage of toughened glass, it is placed in a heat soaking test oven where the glass is slowly heated by two degrees per minute until it reaches 290 °C. It is kept at this temperature for a period of time. This testing process encourages any impurities to break the glass during the test. The glass is then slowly cooled over about two hours, with the complete process generally taking about eight hours.

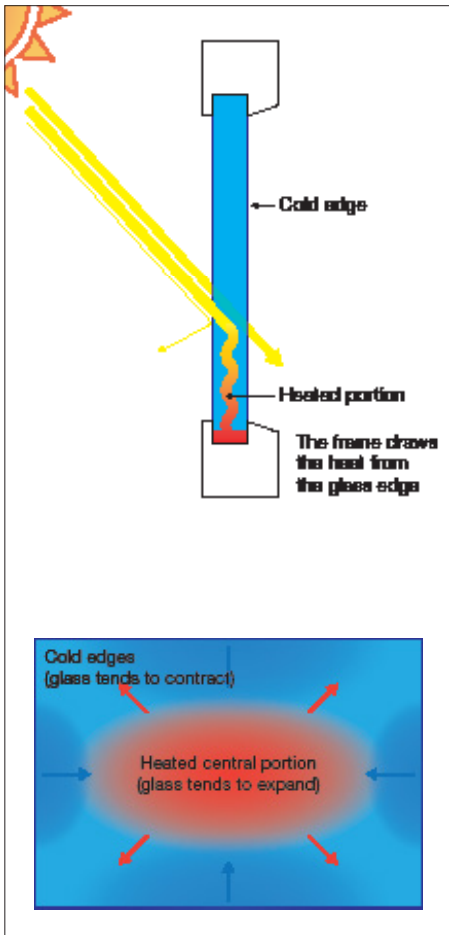
The main technical difference between heat soak and non-heat soak toughened glass is improved reliability in the field. If a serious nickel sulphide problem occurred it might take one to two years before this was recognised whereas the heat soak process would highlight a problem immediately.

---

More information can be found in the AGWA Key Message on Nickel Sulphide Inclusions.

---

# THERMAL STRESS GLASS BREAKAGE



Thermal stress breakage occurs as a result of uneven heating in the glass. Solar energy is the major cause of temperature difference in glass and when part of the glass expands with heat and another part of the glass resists expansion because it is not being heated, stresses build up in the pane. When the stress is greater than the strength of the glass, a thermal break can occur.

Thermal stress is most commonly seen in glass that absorbs and retains heat, such as Low-E and tinted glass, but is not usually a fault of the glass itself. It occurs in many circumstances due to the conditions a pane of glass is exposed to. Generally speaking, the greater the glass edge area, the greater the risk of thermal breakage.

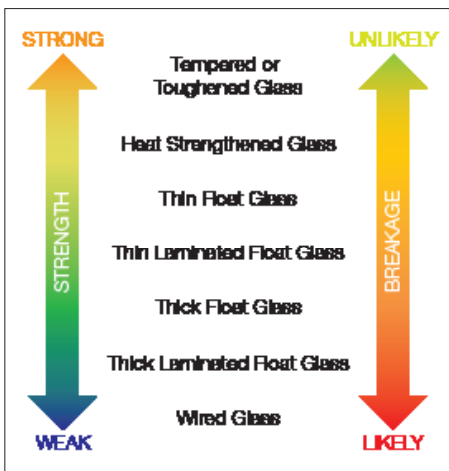
Another important factor in thermal breakage is the quality of the edge finish of the glass pane. Shells, vents or starts increase the likelihood of thermal breakage. All glass should be supplied as per AS 4667 for glass cutting defect limits.

Figure 58 How Thermal Breakage Occurs in Glass

Source: Australian Glass and Window Association

Figure 59 Likelihood of Thermal Breakage as Compared with Glass Strength

Source: Australian Glass and Window Association



## RISK FACTORS

Glass types most at risk of thermal fracture include:

- Solar control glass types (tinted or toned)
- Low-E glass
- Insulating Glass Units

Additional factors that may influence thermal breakage are:

- Glass framing that is in direct contact with concrete or other materials that contribute to the cooling of the glass edge.
- Excessive coverage of the glass edge by the frame.
- Heat-absorbing films attached to the glass after installation.
- External shading on the glass can also have a significant effect on thermal stress.
- Blinds or curtains can have an enormous effect on the thermal stress. Light coloured blinds, close to the glass with a pelmet significantly increase glass stress.
- The airflow from room cooling or heating vents must be directed away from the glass.

When any of the listed risk factors are present, a thermal risk assessment should be conducted by the glass supplier or a suitably qualified person.

More information can be found in the AGWA Key Message on Thermal Breakage in Glass.

# CARE AND MAINTENANCE OF GLASS

## ON-SITE PROTECTION

In order to avoid damage to the finished surfaces, the glass should not be marked or have anything attached directly to the exposed glass or framing surfaces.

Paint, concrete, mortar, plaster, drywall spackle or other similar materials can stain, etch or pit glass or metal surfaces if allowed to harden on them. Construction dust, leachate from concrete and rusting from steel can combine with dew or condensation to form chemicals that can etch or stain glass and metal. Such materials should be immediately flushed from the glass or metal with clean water or a suitable solvent. During construction, glass and metal should be cleaned frequently by trained professionals. Glass should be cleaned in accordance with the glass manufacturer's instructions.

An alternate method is to protect the glass with a sheet of plastic or protective film. If protective films are used, the film manufacturer should be consulted for confirmation of material compatibility, assurance against the adhesive staining or etching of glass and guidelines for the maximum duration of adhesion to the glass surface.

Welding, sandblasting or acid washing in the vicinity of the metal framing or glass can cause unsightly damage to both, as well as reduce the strength of the glass. Heavy tarpaulins or plywood should be used for protection. Immediately after an acid washing, the glass must be flushed with clean water. Contact with hydrochloric or hydrofluoric acid will etch glass if not promptly removed. If any welding is to take place above or near glass, the glass surfaces should be protected with plywood or other suitable material to reduce the likelihood of weld splatter damaging the glass surface(s).

It is recommended that glass be protected from any contamination caused by building materials and/or methods used during construction as this greatly simplifies the glass cleaning task at the end of the project. If the glass is not protected during construction, the glass and frames should be cleaned frequently during construction.

## CLEANING

This information is offered as a general guide only. Specific advice on the cleaning of glass should always be sought from the glass manufacturer or professional window cleaner before any glass cleaning is undertaken.

- To clean most glass, simply wipe over the surface with a few drops of methylated spirits on a damp cloth and then polish the surface dry with a lint free cloth.
- Ensure that all the cleaning cloths are free of any abrasive substances.
- Avoid causing extreme temperature changes as this may lead to thermal fracture of the glass (do not direct hot or cold water onto glass).

Some glass types, particularly Low-E varieties, may have special cleaning instructions. In these cases, always follow the manufacturers' recommended instructions to avoid any damage to the glass surface.

## NOTES

- Glass should be cleaned using only cleaning materials that are free of grit and debris (to avoid scratching and marking of the glass surface).
- Only detergents and cleaning solutions that are recommended for cleaning glass should be used.
- Extra care is required where high performance reflective glass is installed. The coated surface can be

susceptible to stains and scratches and therefore requires vigilance during the entire construction process.

- Glass installations which are adjacent to concrete (for example, concrete slab floors) require extra care and cleaning due to the abrasive nature of concrete dust.
- The cleaning of toughened glass requires special care. The glass surface opposite the standards compliance stamp may, as a consequence of the manufacturing process, have 'pickup' on the surface. 'Pickup' is a deposit of very small particles of glass which are fused to the glass surface. A cleaning method which does not dislodge these particles should be employed otherwise scratching of the glass surface may result. Blades or scrapers have been known to dislodge 'pickup' from the glass surface. A soft cloth should be used.
- Do not use cleaners that contain hydrofluoric or phosphoric acid as they are corrosive to the glass surface.
- Do not clean the glass when the glass is hot or in direct sunlight.
- Do not allow cleaning solutions to contact the edges of laminated glass, Insulating Glass Units or mirrors.
- Do not store or place other material in contact with the glass. (This can damage the glass or create a heat trap leading to thermal breakage).
- Abrasive cleaners, powder based cleaners, scouring pads or other harsh materials should not be used to clean windows or other glass products.
- Some tapes or adhesives can stain or damage glass surfaces. Avoid using these materials unless they are known to be easily removed.



# APPENDIX A: GLASS THICKNESS GUIDE TABLES FOR WIND CLASSIFICATIONS ONLY

These tables are for the selection of glass as determined by the wind classification nominated for a window project. They do not incorporate all wind classifications but are a representative guide to those most typically used. For further reference see AS 2047:2014, AS 4055:2012 and AS/NZS 1170.2.

Glass thickness requirements are based on both the Serviceability and Ultimate wind pressures.

For ANNEALED glass in Regions N1-N6, refer to tables 1-6.

For ANNEALED glass in Regions C1-C4, refer to tables 7-10.

For LAMINATED glass in Regions N1-N5, refer to tables 11-14.

For LAMINATED glass in Regions C1-C4, refer to tables 15-18.

For HEAT STRENGTHENED glass in Regions N1-N5, refer to tables 19-23.

For HEAT STRENGTHENED glass in Regions C1-C4, refer to tables 24-27.

For TOUGHENED glass in Regions N1-N5, refer to tables 28-31.














For TOUGHENED glass in Regions N1-N5, refer to tables 32-35.

Each Table has two parts. The first for general wall conditions and the second for corner wind loads.

Reference must be made to Section 5 of AS 1288:2006 to determine any provisions for human impact that may influence the type and thickness of glass required.

These tables are not a substitute for AS 1288 and more accurate figures may be achieved through the use of Sections 3 and 4 of the standard. Proprietary industry glass and glazing software may also result in a more accurate or cost effective solution.

## KEY

3 mm		15 mm	
4 mm		16 mm	
5 mm		19 mm	
6 mm		20 mm	
8 mm		24 mm	
10 mm		25 mm	
12 mm			

GENERAL		Glass Thickness: Monolithic Annealed Glass @ 400 Pa SLS / 600 Pa ULS										
Table 1		Edge 1 (mm)										
Wind Pressure	Edge 2 (mm)	300	450	600	750	900	1050	1200	1350	1500	1650	
		300	3	3	3	3	3	3	3	3	3	3
450	3	3	3	3	3	3	3	3	3	3	3	
600	3	3	3	3	3	3	3	3	3	3	4	
750	3	3	3	3	3	3	3	4	4	4	4	
900	3	3	3	3	3	4	4	4	4	4	4	
1050	3	3	3	3	3	4	4	4	4	4	4	
1200	3	3	3	4	4	4	4	4	4	4	4	
1350	3	3	3	4	4	4	4	4	4	4	4	
1500	3	3	4	4	4	4	4	4	4	4	4	
1650	3	3	4	4	4	4	4	4	4	4	4	
1800	3	3	4	4	4	4	4	4	4	4	4	
1950	3	4	4	4	4	4	4	4	4	4	4	
2100	3	4	4	4	4	4	4	4	4	4	4	
2250	3	4	4	4	4	4	4	4	4	4	4	
2400	3	4	4	4	4	4	4	4	4	4	4	
2550	3	4	4	4	4	4	4	4	4	4	4	
2700	3	4	4	4	4	4	4	4	4	4	4	

CORNER		Glass Thickness: Monolithic Annealed Glass @ 400 Pa SLS / 900 Pa ULS										
Table 1		Edge 1 (mm)										
Wind Pressure	Edge 2 (mm)	300	450	600	750	900	1050	1200	1350	1500	1650	
		300	3	3	3	3	3	3	3	3	3	3
450	3	3	3	3	3	3	3	3	3	3	3	
600	3	3	3	3	3	3	3	3	3	4	4	
750	3	3	3	3	3	3	3	4	4	4	4	
900	3	3	3	3	3	4	4	4	4	4	4	
1050	3	3	3	3	3	4	4	4	4	4	4	
1200	3	3	3	4	4	4	4	4	4	4	4	
1350	3	3	3	4	4	4	4	4	4	4	4	
1500	3	3	4	4	4	4	4	4	4	4	4	
1650	3	3	4	4	4	4	4	4	4	4	4	
1800	3	3	4	4	4	4	4	4	4	4	4	
1950	3	4	4	4	4	4	4	4	4	4	4	
2100	3	4	4	4	4	4	4	4	4	4	4	
2250	3	4	4	4	4	4	4	4	4	4	4	
2400	3	4	4	4	4	4	4	4	4	4	5	
2550	3	4	4	4	4	4	4	4	4	4	5	
2700	3	4	4	4	4	4	4	5	5	5	5	

GENERAL		Glass Thickness: Monolithic Annealed Glass @ 400 Pa SLS / 900 Pa ULS										
Table 2		Edge 1 (mm)										
Wind Pressure	Edge 2 (mm)	300	450	600	750	900	1050	1200	1350	1500	1650	
		300	3	3	3	3	3	3	3	3	3	3
450	3	3	3	3	3	3	3	3	3	3	3	
600	3	3	3	3	3	3	3	3	3	4	4	
750	3	3	3	3	3	3	3	4	4	4	4	
900	3	3	3	3	3	4	4	4	4	4	4	
1050	3	3	3	3	3	4	4	4	4	4	4	
1200	3	3	3	4	4	4	4	4	4	4	4	
1350	3	3	3	4	4	4	4	4	4	4	4	
1500	3	3	4	4	4	4	4	4	4	4	4	
1650	3	3	4	4	4	4	4	4	4	4	4	
1800	3	3	4	4	4	4	4	4	4	4	4	
1950	3	4	4	4	4	4	4	4	4	4	4	
2100	3	4	4	4	4	4	4	4	4	4	4	
2250	3	4	4	4	4	4	4	4	4	4	4	
2400	3	4	4	4	4	4	4	4	4	4	5	
2550	3	4	4	4	4	4	4	4	4	4	5	
2700	3	4	4	4	4	4	4	4	4	4	5	

CORNER		Glass Thickness: Monolithic Annealed Glass @ 600 Pa SLS / 1300 Pa ULS										
Table 2		Edge 1 (mm)										
Wind Pressure	Edge 2 (mm)	300	450	600	750	900	1050	1200	1350	1500	1650	
		300	3	3	3	3	3	3	3	3	3	3
450	3	3	3	3	3	3	3	3	3	3	3	
600	3	3	3	3	3	3	3	3	3	4	4	
750	3	3	3	3	3	3	3	4	4	4	4	
900	3	3	3	3	3	4	4	4	4	4	4	
1050	3	3	3	3	3	4	4	4	4	4	4	
1200	3	3	3	4	4	4	4	4	4	4	4	
1350	3	3	3	4	4	4	4	4	4	4	4	
1500	3	3	4	4	4	4	4	4	4	4	4	
1650	3	3	4	4	4	4	4	4	4	4	5	
1800	3	3	4	4	4	4	4	4	4	5	5	
1950	3	4	4	4	4	4	4	4	5	5	5	
2100	3	4	4	4	4	4	4	4	5	5	5	
2250	3	4	4	4	4	4	4	4	5	5	5	
2400	3	4	4	4	4	4	4	5	5	5	6	
2550	3	4	4	4	4	4	4	5	5	5	6	
2700	3	4	4	4	4	5	4	5	5	5	6	

GENERAL		Glass Thickness: Monolithic Annealed Glass @ 600 Pa SLS / 1400 Pa ULS										
Table 3		Edge 1 (mm)										
Wind Pressure	Edge 2 (mm)	300	450	600	750	900	1050	1200	1350	1500	1650	
		300	3	3	3	3	3	3	3	3	3	3
450	3	3	3	3	3	3	3	3	3	3	3	
600	3	3	3	3	3	3	3	3	3	3	4	
750	3	3	3	3	3	3	4	4	4	4	4	
900	3	3	3	3	3	4	4	4	4	4	4	
1050	3	3	3	3	4	4	4	4	4	4	4	
1200	3	3	3	4	4	4	4	4	4	4	4	
1350	3	3	3	4	4	4	4	4	4	4	4	
1500	3	3	4	4	4	4	4	4	4	4	5	
1650	3	3	4	4	4	4	4	4	4	5	5	
1800	3	3	4	4	4	4	4	4	5	5	5	
1950	3	4	4	4	4	4	4	4	5	5	5	
2100	3	4	4	4	4	4	4	5	5	5	5	
2250	3	4	4	4	4	4	4	5	5	5	6	
2400	3	4	4	4	4	4	4	5	5	5	6	
2550	3	4	4	4	4	4	4	5	5	6	6	
2700	3	4	4	4	4	5	5	5	5	6	6	

CORNER		Glass Thickness: Monolithic Annealed Glass @ 800 Pa SLS / 2000 Pa ULS										
Table 3		Edge 1 (mm)										
Wind Pressure	Edge 2 (mm)	300	450	600	750	900	1050	1200	1350	1500	1650	
		300	3	3	3	3	3	3	3	3	3	3
450	3	3	3	3	3	3	3	3	3	3	3	
600	3	3	3	3	3	3	3	3	3	3	4	
750	3	3	3	3	3	3	3	4	4	4	4	
900	3	3	3	3	3	4	4	4	4	4	4	
1050	3	3	3	3	4	4	4	4	4	5	5	
1200	3	3	3	4	4	4	4	4	5	5	5	
1350	3	3	3	4	4	4	4	5	5	5	5	
1500	3	3	4	4	4	4	5	5	5	5	6	
1650	3	3	4	4	4	4	5	5	5	6	6	
1800	3	3	4	4	4	4	5	5	6	6	6	
1950	3	4	4	4	4	5	5	5	6	6	6	
2100	3	4	4	4	5	5	5	6	6	6	8	
2250	3	4	4	4	5	5	5	6	6	8	8	
2400	3	4	4	4	5	5	5	6	6	8	8	
2550	3	4	4	4	5	5	5	6	6	8	8	
2700	3	4	4	4	5	6	6	6	8	8	8	

GENERAL		Glass Thickness: Monolithic Annealed Glass @ 800 Pa SLS / 2000 Pa ULS										
Table 4		Edge 1 (mm)										
Wind Pressure	Edge 2 (mm)	300	450	600	750	900	1050	1200	1350	1500	1650	
		300	3	3	3	3	3	3	3	3	3	3
450	3	3	3	3	3	3	3	3	3	3	3	
600	3	3	3	3	3	3	3	3	3	4	4	
750	3	3	3	3	3	3	4	4	4	4	4	
900	3	3	3	3	3	4	4	4	4	4	4	
1050	3	3	3	3	4	4	4	4	4	5	5	
1200	3	3	3	4	4	4	4	4	5	5	5	
1350	3	3	3	4	4	4	4	5	5	5	5	
1500	3	3	4	4	4	4	5	5	5	5	6	
1650	3	3	4	4	4	4	5	5	6	6	6	
1800	3	3	4	4	4	4	5	5	6	6	6	
1950	3	4	4	4	5	5	5	5	6	6	6	
2100	3	4	4	5	5	5	6	6	6	8	8	
2250	3	4	4	5	5	5	6	6	8	8	8	
2400	3	4	4	5	5	5	6	6	8	8	8	
2550	3	4	4	5	5	5	6	6	8	8	8	
2700	3	4	4	5	6	6	6	8	8	8	8	

CORNER		Glass Thickness: Monolithic Annealed Glass @ 1200 Pa SLS / 3000 Pa ULS										
Table 4		Edge 1 (mm)										
Wind Pressure	Edge 2 (mm)	300	450	600	750	900	1050	1200	1350	1500	1650	
		300	3	3	3	3	3	3	3	3	3	3
450	3	3	3	3	3	3	3	3	4	4	4	
600	3	3	3	3	3	4	4	4	4	4	5	
750	3	3	3	3	3	4	4	4	5	5	5	
900	3	3	4	4	4	4	4	5	5	5	6	
1050	3	3	4	4	4	4	5	5	5	6	6	
1200	3	3	4	4	4	5	5	5	6	6	6	
1350	3	4	4	5	5	5	6	6	6	8	8	
1500	3	4	4	5	5	6	6	6	8	8	8	
1650	3	4	5	5	6	6	6	8	8	8	8	
1800	3	4	5	5	6	6	8	8	8	8	8	
1950	3	4	5	5	6	8	8	8	8	8	8	
2100	3	4	5	6	6	8	8	8	8	8	8	
2250	3	4	5	6	6	8	8	8	10	10	10	
2400	3	5	5	6	8	8	8	8	10	10	10	
2550	3	5	5	6	8	8	8	10	10	10	10	
2700	3	5	5	6	8	8	8	10	10	10	10	





CORNER														
Glass Thickness: Monolithic Annealed Glass @ 800 Pa SLS / 2700 Pa ULS														
Table 7	Wind Pressure	Edge 1 (mm)												
		300	450	600	750	900	1050	1200	1350	1500	1650			
	300	3	3	3	3	3	3	3	3	3	3	3	3	3
	450	3	3	3	3	3	3	3	3	3	3	3	4	4
	600	3	3	3	3	3	3	3	3	3	3	4	4	4
	750	3	3	3	3	3	3	4	4	4	4	4	5	5
	900	3	3	3	3	4	4	4	4	4	4	5	5	5
	1050	3	3	3	3	4	4	4	4	4	5	5	5	6
	1200	3	3	3	4	4	4	4	5	5	5	5	6	6
	1350	3	4	4	4	4	5	5	5	5	5	6	6	6
	1500	3	4	4	4	5	5	5	5	6	6	6	6	8
	1650	3	4	4	4	5	5	5	6	6	6	6	8	8
	1800	3	4	4	5	5	5	5	6	6	8	8	8	8
	1950	3	4	4	4	5	5	5	6	6	8	8	8	8
	2100	3	4	4	4	5	5	6	6	6	8	8	8	8
	2250	3	4	4	4	5	6	6	6	6	8	8	8	8
	2400	3	4	4	4	5	6	6	6	6	8	8	8	10
	2550	3	4	4	4	5	6	8	8	8	8	8	10	10
	2700	3	4	4	4	5	6	8	8	8	8	8	10	10

GENERAL														
Glass Thickness: Monolithic Annealed Glass @ 600 Pa SLS / 1800 Pa ULS														
Table 7	Wind Pressure	Edge 1 (mm)												
		300	450	600	750	900	1050	1200	1350	1500	1650			
	300	3	3	3	3	3	3	3	3	3	3	3	3	3
	450	3	3	3	3	3	3	3	3	3	3	3	3	3
	600	3	3	3	3	3	3	3	3	3	3	4	4	4
	750	3	3	3	3	3	3	3	4	4	4	4	4	4
	900	3	3	3	3	3	4	4	4	4	4	4	4	4
	1050	3	3	3	3	4	4	4	4	4	4	4	4	4
	1200	3	3	3	4	4	4	4	4	4	4	5	5	5
	1350	3	3	3	4	4	4	4	4	4	5	5	5	5
	1500	3	3	4	4	4	4	4	5	5	5	5	5	5
	1650	3	3	4	4	4	4	4	5	5	5	5	6	6
	1800	3	3	4	4	4	4	5	5	5	5	5	6	6
	1950	3	4	4	4	4	4	5	5	5	5	6	6	6
	2100	3	4	4	4	4	5	5	5	6	6	6	6	6
	2250	3	4	4	4	5	5	5	5	6	6	6	6	6
	2400	3	4	4	4	5	5	5	5	6	6	6	6	8
	2550	3	4	4	4	5	5	5	5	6	6	6	6	8
	2700	3	4	4	4	5	6	6	6	6	6	6	8	8

CORNER														
Glass Thickness: Monolithic Annealed Glass @ 1200 Pa SLS / 4000 Pa ULS														
Table 8	Wind Pressure	Edge 1 (mm)												
		300	450	600	750	900	1050	1200	1350	1500	1650			
	300	3	3	3	3	3	3	3	3	3	3	3	3	4
	450	3	3	3	3	3	3	4	4	4	4	4	4	5
	600	3	3	3	3	4	4	4	4	4	5	5	5	5
	750	3	3	3	4	4	4	4	5	5	5	6	6	6
	900	3	4	4	4	4	5	5	5	5	6	6	6	8
	1050	3	4	4	4	5	5	5	5	6	6	6	8	8
	1200	3	4	4	5	5	6	6	6	6	8	8	8	8
	1350	3	4	4	5	6	6	6	6	8	8	8	8	8
	1500	3	4	4	5	6	6	6	8	8	8	8	8	8
	1650	4	5	5	5	6	8	8	8	8	8	8	8	10
	1800	4	5	6	6	6	8	8	8	8	8	10	10	10
	1950	4	5	6	6	6	8	8	10	10	10	10	10	10
	2100	4	5	6	8	8	8	8	10	10	10	10	10	10
	2250	4	5	6	8	8	8	10	10	10	10	12	12	12
	2400	4	5	6	8	8	8	10	10	10	10	12	12	12
	2550	4	5	6	8	8	8	10	10	10	10	12	12	12
	2700	4	5	6	8	8	10	10	10	10	10	12	12	12

GENERAL														
Glass Thickness: Monolithic Annealed Glass @ 800 Pa SLS / 2700 Pa ULS														
Table 8	Wind Pressure	Edge 1 (mm)												
		300	450	600	750	900	1050	1200	1350	1500	1650			
	300	3	3	3	3	3	3	3	3	3	3	3	3	3
	450	3	3	3	3	3	3	3	3	3	4	4	4	4
	600	3	3	3	3	3	3	3	4	4	4	4	4	4
	750	3	3	3	3	4	4	4	4	4	4	5	5	5
	900	3	3	3	4	4	4	4	4	4	5	5	5	5
	1050	3	3	3	4	4	4	4	5	5	5	5	6	6
	1200	3	3	4	4	4	4	5	5	5	5	6	6	6
	1350	3	4	4	4	4	5	5	5	6	6	6	6	6
	1500	3	4	4	4	5	5	5	6	6	6	6	8	8
	1650	3	4	4	4	5	5	6	6	6	6	8	8	8
	1800	3	4	5	5	5	5	6	6	8	8	8	8	8
	1950	3	4	5	5	5	6	6	6	8	8	8	8	8
	2100	3	4	5	5	6	6	6	6	8	8	8	8	8
	2250	3	4	5	6	6	6	6	6	8	8	8	8	8
	2400	3	4	5	6	6	6	6	6	8	8	8	10	10
	2550	3	4	5	6	6	8	8	8	8	8	10	10	10
	2700	3	4	5	6	6	8	8	8	8	8	10	10	10

GENERAL													
Glass Thickness: Monolithic Annealed Glass @ 1200 Pa SLS / 4000 Pa ULS													
Table 9	Wind Pressure	Edge 1 (mm)											
		300	450	600	750	900	1050	1200	1350	1500	1650		
	300	3	3	3	3	3	3	3	3	3	3	3	4
	450	3	3	3	3	4	4	4	4	4	4	4	5
	600	3	3	3	4	4	4	4	5	5	5	5	5
	750	3	3	4	4	4	4	5	5	5	6	6	6
	900	3	4	4	4	5	5	5	6	6	6	6	8
	1050	3	4	4	5	5	5	5	6	6	6	8	8
	1200	3	4	5	5	6	6	6	6	8	8	8	8
	1350	3	4	5	6	6	6	8	8	8	8	8	8
	1500	3	4	5	6	6	8	8	8	8	8	8	8
	1650	4	5	5	6	8	8	8	8	8	10	10	10
	1800	4	5	6	6	8	8	8	8	10	10	10	10
	1950	4	5	6	6	8	8	10	10	10	10	10	10
	2100	4	5	6	8	8	8	10	10	10	10	10	10
	2250	4	5	6	8	8	10	10	10	10	12	12	12
	2400	4	5	6	8	8	10	10	10	10	12	12	12
	2550	4	5	6	8	8	10	10	10	12	12	12	12
	2700	4	5	6	8	8	10	10	10	12	12	12	12

CORNER													
Glass Thickness: Monolithic Annealed Glass @ 1800 Pa SLS / 5900 Pa ULS													
Table 9	Wind Pressure	Edge 1 (mm)											
		300	450	600	750	900	1050	1200	1350	1500	1650		
	300	3	3	3	3	4	4	4	4	4	4	4	4
	450	3	3	4	4	5	5	5	5	5	5	5	5
	600	3	4	4	4	5	6	6	6	6	6	6	8
	750	3	4	4	5	5	6	8	8	8	8	8	8
	900	4	5	5	5	6	6	8	8	8	10	10	10
	1050	4	5	6	6	8	8	8	8	10	10	10	10
	1200	4	5	6	8	8	8	8	8	10	10	10	10
	1350	4	5	6	8	8	8	10	10	10	10	10	10
	1500	4	5	6	8	10	10	10	10	10	10	12	12
	1650	4	5	8	8	10	10	10	10	12	12	12	12
	1800	4	6	8	8	10	10	12	12	12	12	12	12
	1950	4	6	8	8	10	12	12	12	12	12	12	12
	2100	4	6	8	10	10	12	12	12	15	15	15	15
	2250	4	6	8	10	10	12	12	15	15	15	15	15
	2400	4	6	8	10	10	12	12	15	15	15	15	15
	2550	4	6	8	10	12	12	12	15	15	15	15	19
	2700	4	6	8	10	12	12	12	15	15	19	19	19

GENERAL													
Glass Thickness: Monolithic Annealed Glass @ 1600 Pa SLS / 5300 Pa ULS													
Table 10	Wind Pressure	Edge 1 (mm)											
		300	450	600	750	900	1050	1200	1350	1500	1650		
	300	3	3	3	3	4	4	4	4	4	4	4	4
	450	3	3	3	4	4	4	4	5	5	5	5	5
	600	3	3	4	4	4	5	5	6	6	6	6	6
	750	3	4	4	5	5	6	6	6	8	8	8	8
	900	4	4	5	5	6	6	8	8	8	8	8	8
	1050	4	4	5	6	6	6	8	8	8	8	10	10
	1200	4	5	6	6	8	8	8	8	8	8	10	10
	1350	4	5	6	8	8	8	8	8	10	10	10	10
	1500	4	5	6	8	8	8	8	10	10	10	10	10
	1650	4	5	6	8	8	10	10	10	10	10	10	10
	1800	4	5	8	8	10	10	10	10	10	10	12	12
	1950	4	5	8	8	10	10	10	12	12	12	12	12
	2100	4	5	8	8	10	12	12	12	12	12	12	12
	2250	4	5	8	10	10	12	12	12	15	15	15	15
	2400	4	6	8	10	10	12	12	12	15	15	15	15
	2550	4	6	8	10	10	12	12	12	15	15	15	15
	2700	4	6	8	10	10	12	12	12	15	15	15	15

CORNER													
Glass Thickness: Monolithic Annealed Glass @ 2500 Pa SLS / 8000 Pa ULS													
Table 10	Wind Pressure	Edge 1 (mm)											
		300	450	600	750	900	1050	1200	1350	1500	1650		
	300	3	3	4	4	4	4	4	4	4	4	4	5
	450	3	4	4	5	6	6	6	6	6	6	6	6
	600	4	4	5	5	6	8	8	8	8	8	8	8
	750	4	5	5	6	6	8	10	10	10	10	10	10
	900	4	6	6	6	8	8	10	10	10	10	12	12
	1050	4	6	8	8	8	8	10	10	10	10	12	12
	1200	4	6	8	10	10	10	10	10	10	10	12	12
	1350	4	6	8	10	10	10	10	10	10	12	12	12
	1500	4	6	8	10	12	12	12	12	12	12	12	15
	1650	5	6	8	10	12	12	12	12	12	12	15	15
	1800	5	6	10	10	15	15	15	15	15	15	15	15
	1950	5	6	10	10	15	15	15	15	15	15	15	15
	2100	5	6	10	12	15	15	15	15	19	19	19	19
	2250	5	6	10	12	15	15	15	15	19	19	19	19
	2400	5	8	10	12	15	15	15	15	19	19	19	19
	2550	5	8	10	12	15	15	15	15	19	25	25	25
	2700	5	8	10	12	15	15	15	15	19	25	25	25

GENERAL														
Glass Thickness: Laminated Annealed Glass @ 400 Pa SLS / 600 Pa ULS														
Table 11	Wind Pressure	Edge 1 (mm)												
		300	450	600	750	900	1050	1200	1350	1500	1650			
	300	5	5	5	5	5	5	5	5	5	5	5	5	5
	450	5	5	5	5	5	5	5	5	5	5	5	5	5
	600	5	5	5	5	5	5	5	5	5	5	5	5	5
	750	5	5	5	5	5	5	5	5	5	5	5	5	5
	900	5	5	5	5	5	5	5	5	5	5	5	5	5
	1050	5	5	5	5	5	5	5	5	5	5	5	5	5
	1200	5	5	5	5	5	5	5	5	5	5	5	5	5
	1350	5	5	5	5	5	5	5	5	5	5	5	5	5
	1500	5	5	5	5	5	5	5	5	5	5	5	5	5
	1650	5	5	5	5	5	5	5	5	5	5	5	5	5
	1800	5	5	5	5	5	5	5	5	5	5	5	5	5
	1950	5	5	5	5	5	5	5	5	5	5	5	5	5
	2100	5	5	5	5	5	5	5	5	5	5	5	5	5
	2250	5	5	5	5	5	5	5	5	5	5	5	5	5
	2400	5	5	5	5	5	5	5	5	5	5	5	5	5
	2550	5	5	5	5	5	5	5	5	5	5	5	5	5
	2700	5	5	5	5	5	5	5	5	5	5	5	5	5
		Edge 2 (mm)												
		N1												

CORNER														
Glass Thickness: Laminated Annealed Glass @ 600 Pa SLS / 900 Pa ULS														
Table 11	Wind Pressure	Edge 1 (mm)												
		300	450	600	750	900	1050	1200	1350	1500	1650			
	300	5	5	5	5	5	5	5	5	5	5	5	5	5
	450	5	5	5	5	5	5	5	5	5	5	5	5	5
	600	5	5	5	5	5	5	5	5	5	5	5	5	5
	750	5	5	5	5	5	5	5	5	5	5	5	5	5
	900	5	5	5	5	5	5	5	5	5	5	5	5	5
	1050	5	5	5	5	5	5	5	5	5	5	5	5	5
	1200	5	5	5	5	5	5	5	5	5	5	5	5	5
	1350	5	5	5	5	5	5	5	5	5	5	5	5	5
	1500	5	5	5	5	5	5	5	5	5	5	5	5	5
	1650	5	5	5	5	5	5	5	5	5	5	5	5	5
	1800	5	5	5	5	5	5	5	5	5	5	5	5	5
	1950	5	5	5	5	5	5	5	5	5	5	5	5	5
	2100	5	5	5	5	5	5	5	5	5	5	5	5	5
	2250	5	5	5	5	5	5	5	5	5	5	5	5	5
	2400	5	5	5	5	5	5	5	5	5	5	5	5	5
	2550	5	5	5	5	5	5	5	5	5	5	5	5	5
	2700	5	5	5	5	5	5	5	5	5	5	5	5	5
		Edge 2 (mm)												
		N1												

GENERAL														
Glass Thickness: Laminated Annealed Glass @ 400 Pa SLS / 900 Pa ULS														
Table 12	Wind Pressure	Edge 1 (mm)												
		300	450	600	750	900	1050	1200	1350	1500	1650			
	300	5	5	5	5	5	5	5	5	5	5	5	5	5
	450	5	5	5	5	5	5	5	5	5	5	5	5	5
	600	5	5	5	5	5	5	5	5	5	5	5	5	5
	750	5	5	5	5	5	5	5	5	5	5	5	5	5
	900	5	5	5	5	5	5	5	5	5	5	5	5	5
	1050	5	5	5	5	5	5	5	5	5	5	5	5	5
	1200	5	5	5	5	5	5	5	5	5	5	5	5	5
	1350	5	5	5	5	5	5	5	5	5	5	5	5	5
	1500	5	5	5	5	5	5	5	5	5	5	5	5	5
	1650	5	5	5	5	5	5	5	5	5	5	5	5	5
	1800	5	5	5	5	5	5	5	5	5	5	5	5	5
	1950	5	5	5	5	5	5	5	5	5	5	5	5	5
	2100	5	5	5	5	5	5	5	5	5	5	5	5	5
	2250	5	5	5	5	5	5	5	5	5	5	5	5	5
	2400	5	5	5	5	5	5	5	5	5	5	5	5	5
	2550	5	5	5	5	5	5	5	5	5	5	5	5	5
	2700	5	5	5	5	5	5	5	5	5	5	5	5	5
		Edge 2 (mm)												
		N2												

CORNER														
Glass Thickness: Laminated Annealed Glass @ 600 Pa SLS / 1300 Pa ULS														
Table 12	Wind Pressure	Edge 1 (mm)												
		300	450	600	750	900	1050	1200	1350	1500	1650			
	300	5	5	5	5	5	5	5	5	5	5	5	5	5
	450	5	5	5	5	5	5	5	5	5	5	5	5	5
	600	5	5	5	5	5	5	5	5	5	5	5	5	5
	750	5	5	5	5	5	5	5	5	5	5	5	5	5
	900	5	5	5	5	5	5	5	5	5	5	5	5	5
	1050	5	5	5	5	5	5	5	5	5	5	5	5	5
	1200	5	5	5	5	5	5	5	5	5	5	5	5	5
	1350	5	5	5	5	5	5	5	5	5	5	5	5	5
	1500	5	5	5	5	5	5	5	5	5	5	5	5	5
	1650	5	5	5	5	5	5	5	5	5	5	5	5	5
	1800	5	5	5	5	5	5	5	5	5	5	5	5	5
	1950	5	5	5	5	5	5	5	5	5	5	5	5	5
	2100	5	5	5	5	5	5	5	5	5	5	5	5	5
	2250	5	5	5	5	5	5	5	5	5	5	5	5	6
	2400	5	5	5	5	5	5	5	5	5	5	5	5	6
	2550	5	5	5	5	5	5	5	5	5	5	5	5	6
	2700	5	5	5	5	5	5	5	5	5	5	5	5	6
		Edge 2 (mm)												
		N2												

GENERAL														
Glass Thickness: Laminated Annealed Glass @ 600 Pa SLS / 1400 Pa ULS														
Table 13	Wind Pressure	Edge 1 (mm)												
		300	450	600	750	900	1050	1200	1350	1500	1650			
	300	5	5	5	5	5	5	5	5	5	5	5	5	5
	450	5	5	5	5	5	5	5	5	5	5	5	5	5
	600	5	5	5	5	5	5	5	5	5	5	5	5	5
	750	5	5	5	5	5	5	5	5	5	5	5	5	5
	900	5	5	5	5	5	5	5	5	5	5	5	5	5
	1050	5	5	5	5	5	5	5	5	5	5	5	5	5
	1200	5	5	5	5	5	5	5	5	5	5	5	5	5
	1350	5	5	5	5	5	5	5	5	5	5	5	5	5
	1500	5	5	5	5	5	5	5	5	5	5	5	5	5
	1650	5	5	5	5	5	5	5	5	5	5	5	5	5
	1800	5	5	5	5	5	5	5	5	5	5	5	5	5
	1950	5	5	5	5	5	5	5	5	5	5	5	5	5
	2100	5	5	5	5	5	5	5	5	5	5	5	5	6
	2250	5	5	5	5	5	5	5	5	5	5	5	6	6
	2400	5	5	5	5	5	5	5	5	5	5	5	6	6
	2550	5	5	5	5	5	5	5	5	5	5	5	6	6
	2700	5	5	5	5	5	5	5	5	5	5	5	6	6

CORNER														
Glass Thickness: Laminated Annealed Glass @ 800 Pa SLS / 2000 Pa ULS														
Table 13	Wind Pressure	Edge 1 (mm)												
		300	450	600	750	900	1050	1200	1350	1500	1650			
	300	5	5	5	5	5	5	5	5	5	5	5	5	5
	450	5	5	5	5	5	5	5	5	5	5	5	5	5
	600	5	5	5	5	5	5	5	5	5	5	5	5	5
	750	5	5	5	5	5	5	5	5	5	5	5	5	5
	900	5	5	5	5	5	5	5	5	5	5	5	5	5
	1050	5	5	5	5	5	5	5	5	5	5	5	5	5
	1200	5	5	5	5	5	5	5	5	5	5	5	5	5
	1350	5	5	5	5	5	5	5	5	5	5	5	5	5
	1500	5	5	5	5	5	5	5	5	5	5	5	5	6
	1650	5	5	5	5	5	5	5	5	5	5	5	6	6
	1800	5	5	5	5	5	5	5	5	5	5	5	6	6
	1950	5	5	5	5	5	5	5	5	5	5	5	6	6
	2100	5	5	5	5	5	5	5	5	5	5	5	6	8
	2250	5	5	5	5	5	5	5	5	5	5	5	6	8
	2400	5	5	5	5	5	5	5	5	5	5	5	6	8
	2550	5	5	5	5	5	5	5	5	5	5	5	6	8
	2700	5	5	5	5	5	5	5	5	5	5	5	6	8

GENERAL														
Glass Thickness: Laminated Annealed Glass @ 800 Pa SLS / 2000 Pa ULS														
Table 14	Wind Pressure	Edge 1 (mm)												
		300	450	600	750	900	1050	1200	1350	1500	1650			
	300	5	5	5	5	5	5	5	5	5	5	5	5	5
	450	5	5	5	5	5	5	5	5	5	5	5	5	5
	600	5	5	5	5	5	5	5	5	5	5	5	5	5
	750	5	5	5	5	5	5	5	5	5	5	5	5	5
	900	5	5	5	5	5	5	5	5	5	5	5	5	5
	1050	5	5	5	5	5	5	5	5	5	5	5	5	5
	1200	5	5	5	5	5	5	5	5	5	5	5	5	5
	1350	5	5	5	5	5	5	5	5	5	5	5	5	5
	1500	5	5	5	5	5	5	5	5	5	5	5	5	6
	1650	5	5	5	5	5	5	5	5	5	5	5	6	6
	1800	5	5	5	5	5	5	5	5	5	5	5	6	6
	1950	5	5	5	5	5	5	5	5	5	5	5	6	8
	2100	5	5	5	5	5	5	5	5	5	5	5	6	8
	2250	5	5	5	5	5	5	5	5	5	5	5	6	8
	2400	5	5	5	5	5	5	5	5	5	5	5	6	8
	2550	5	5	5	5	5	5	5	5	5	5	5	6	8
	2700	5	5	5	5	5	5	5	5	5	5	5	6	8

CORNER														
Glass Thickness: Laminated Annealed Glass @ 1200 Pa SLS / 3000 Pa ULS														
Table 14	Wind Pressure	Edge 1 (mm)												
		300	450	600	750	900	1050	1200	1350	1500	1650			
	300	5	5	5	5	5	5	5	5	5	5	5	5	5
	450	5	5	5	5	5	5	5	5	5	5	5	5	5
	600	5	5	5	5	5	5	5	5	5	5	5	5	5
	750	5	5	5	5	5	5	5	5	5	5	5	5	5
	900	5	5	5	5	5	5	5	5	5	5	5	5	6
	1050	5	5	5	5	5	5	5	5	5	5	5	5	6
	1200	5	5	5	5	5	5	5	5	5	5	5	5	6
	1350	5	5	5	5	5	5	5	5	5	5	5	5	6
	1500	5	5	5	5	5	5	5	5	5	5	5	5	6
	1650	5	5	5	5	5	5	5	5	5	5	5	5	6
	1800	5	5	5	5	5	5	5	5	5	5	5	5	6
	1950	5	5	5	5	5	5	5	5	5	5	5	5	6
	2100	5	5	5	5	5	5	5	5	5	5	5	5	6
	2250	5	5	5	5	5	5	5	5	5	5	5	5	6
	2400	5	5	5	5	5	5	5	5	5	5	5	5	6
	2550	5	5	5	5	5	5	5	5	5	5	5	5	6
	2700	5	5	5	5	5	5	5	5	5	5	5	5	6

GENERAL												
Table 15 Glass Thickness: Laminated Annealed Glass @ 1200 Pa SLS / 3000 Pa ULS												
Wind Pressure	Edge 1 (mm)											
	300	450	600	750	900	1050	1200	1350	1500	1650		
300	5	5	5	5	5	5	5	5	5	5	5	5
450	5	5	5	5	5	5	5	5	5	5	5	5
600	5	5	5	5	5	5	5	5	5	5	5	5
750	5	5	5	5	5	5	5	5	5	5	5	5
900	5	5	5	5	5	5	5	5	5	6	6	6
1050	5	5	5	5	5	5	5	5	5	6	6	6
1200	5	5	5	5	5	5	5	5	5	6	6	6
1350	5	5	5	5	5	5	5	5	5	6	6	6
1500	5	5	5	5	5	5	5	5	5	6	6	6
1650	5	5	5	5	5	5	5	5	5	6	6	6
1800	5	5	5	5	5	5	5	5	5	6	6	6
1950	5	5	5	5	5	5	5	5	5	6	6	6
2100	5	5	5	5	5	5	5	5	5	6	6	6
2250	5	5	5	5	5	5	5	5	5	6	6	6
2400	5	5	5	5	5	5	5	5	5	6	6	6
2550	5	5	5	5	5	5	5	5	5	6	6	6
2700	5	5	5	5	5	5	5	5	5	6	6	6

CORNER												
Table 15 Glass Thickness: Laminated Annealed Glass @ 1800 Pa SLS / 4500 Pa ULS												
Wind Pressure	Edge 1 (mm)											
	300	450	600	750	900	1050	1200	1350	1500	1650		
300	5	5	5	5	5	5	5	5	5	5	5	5
450	5	5	5	5	5	5	5	5	5	5	5	5
600	5	5	5	5	5	5	5	5	5	5	5	5
750	5	5	5	5	5	5	5	5	5	5	5	5
900	5	5	5	5	5	5	5	5	5	5	5	5
1050	5	5	5	5	5	5	5	5	5	5	5	5
1200	5	5	5	5	5	5	5	5	5	5	5	5
1350	5	5	5	5	5	5	5	5	5	5	5	5
1500	5	5	5	5	5	5	5	5	5	5	5	5
1650	5	5	5	5	5	5	5	5	5	5	5	5
1800	5	5	5	5	5	5	5	5	5	5	5	5
1950	5	5	5	5	5	5	5	5	5	5	5	5
2100	5	5	5	5	5	5	5	5	5	5	5	5
2250	5	5	5	5	5	5	5	5	5	5	5	5
2400	5	5	5	5	5	5	5	5	5	5	5	5
2550	5	5	5	5	5	5	5	5	5	5	5	5
2700	5	5	5	5	5	5	5	5	5	5	5	5

GENERAL												
Table 16 Glass Thickness: Laminated Annealed Glass @ 1600 Pa SLS / 4000 Pa ULS												
Wind Pressure	Edge 1 (mm)											
	300	450	600	750	900	1050	1200	1350	1500	1650		
300	5	5	5	5	5	5	5	5	5	5	5	5
450	5	5	5	5	5	5	5	5	5	5	5	5
600	5	5	5	5	5	5	5	5	5	5	5	5
750	5	5	5	5	5	5	5	5	5	5	5	5
900	5	5	5	5	5	5	5	5	5	5	5	5
1050	5	5	5	5	5	5	5	5	5	5	5	5
1200	5	5	5	5	5	5	5	5	5	5	5	5
1350	5	5	5	5	5	5	5	5	5	5	5	5
1500	5	5	5	5	5	5	5	5	5	5	5	5
1650	5	5	5	5	5	5	5	5	5	5	5	5
1800	5	5	5	5	5	5	5	5	5	5	5	5
1950	5	5	5	5	5	5	5	5	5	5	5	5
2100	5	5	5	5	5	5	5	5	5	5	5	5
2250	5	5	5	5	5	5	5	5	5	5	5	5
2400	5	5	5	5	5	5	5	5	5	5	5	5
2550	5	5	5	5	5	5	5	5	5	5	5	5
2700	5	5	5	5	5	5	5	5	5	5	5	5

CORNER												
Table 16 Glass Thickness: Laminated Annealed Glass @ 2500 Pa SLS / 6000 Pa ULS												
Wind Pressure	Edge 1 (mm)											
	300	450	600	750	900	1050	1200	1350	1500	1650		
300	5	5	5	5	5	5	5	5	5	5	5	5
450	5	5	5	5	5	5	5	5	5	5	5	5
600	5	5	5	5	5	5	5	5	5	5	5	5
750	5	5	5	5	5	5	5	5	5	5	5	5
900	5	5	5	5	5	5	5	5	5	5	5	5
1050	5	5	5	5	5	5	5	5	5	5	5	5
1200	5	5	5	5	5	5	5	5	5	5	5	5
1350	5	5	5	5	5	5	5	5	5	5	5	5
1500	5	5	5	5	5	5	5	5	5	5	5	5
1650	5	5	5	5	5	5	5	5	5	5	5	5
1800	5	5	5	5	5	5	5	5	5	5	5	5
1950	5	5	5	5	5	5	5	5	5	5	5	5
2100	5	5	5	5	5	5	5	5	5	5	5	5
2250	5	5	5	5	5	5	5	5	5	5	5	5
2400	5	5	5	5	5	5	5	5	5	5	5	5
2550	5	5	5	5	5	5	5	5	5	5	5	5
2700	5	5	5	5	5	5	5	5	5	5	5	5

GENERAL												
Table 17 Glass Thickness: Laminated Annealed Glass @ 600 Pa SLS / 1800 Pa ULS												
Wind Pressure	Edge 1 (mm)											
	300	450	600	750	900	1050	1200	1350	1500	1650		
300	5	5	5	5	5	5	5	5	5	5	5	5
450	5	5	5	5	5	5	5	5	5	5	5	5
600	5	5	5	5	5	5	5	5	5	5	5	5
750	5	5	5	5	5	5	5	5	5	5	5	5
900	5	5	5	5	5	5	5	5	5	5	5	5
1050	5	5	5	5	5	5	5	5	5	5	5	5
1200	5	5	5	5	5	5	5	5	5	5	5	5
1350	5	5	5	5	5	5	5	5	5	5	5	5
1500	5	5	5	5	5	5	5	5	5	5	5	5
1650	5	5	5	5	5	5	5	5	5	5	5	6
1800	5	5	5	5	5	5	5	5	5	5	6	6
1950	5	5	5	5	5	5	5	5	6	6	6	6
2100	5	5	5	5	5	5	5	5	6	6	6	6
2250	5	5	5	5	5	5	5	6	6	6	6	8
2400	5	5	5	5	5	5	5	6	6	6	8	8
2550	5	5	5	5	5	5	5	6	6	6	8	8
2700	5	5	5	5	6	6	6	6	6	6	8	8

CORNER												
Table 17 Glass Thickness: Laminated Annealed Glass @ 800 Pa SLS / 2700 Pa ULS												
Wind Pressure	Edge 1 (mm)											
	300	450	600	750	900	1050	1200	1350	1500	1650		
300	5	5	5	5	5	5	5	5	5	5	5	5
450	5	5	5	5	5	5	5	5	5	5	5	5
600	5	5	5	5	5	5	5	5	5	5	5	5
750	5	5	5	5	5	5	5	5	5	5	5	5
900	5	5	5	5	5	5	5	5	5	5	5	5
1050	5	5	5	5	5	5	5	5	5	5	5	6
1200	5	5	5	5	5	5	5	5	5	6	6	6
1350	5	5	5	5	5	5	5	6	6	6	6	6
1500	5	5	5	5	5	5	5	6	6	6	6	8
1650	5	5	5	5	5	5	5	6	6	6	6	8
1800	5	5	5	5	5	6	6	6	6	8	8	8
1950	5	5	5	5	5	6	6	6	6	8	8	8
2100	5	5	5	5	6	6	6	6	6	8	8	8
2250	5	5	5	5	6	6	6	6	6	8	8	8
2400	5	5	5	5	6	6	6	6	6	8	8	10
2550	5	5	5	5	6	6	6	6	6	8	8	10
2700	5	5	5	5	6	6	6	6	6	8	8	10

GENERAL												
Table 18 Glass Thickness: Laminated Annealed Glass @ 800 Pa SLS / 2700 Pa ULS												
Wind Pressure	Edge 1 (mm)											
	300	450	600	750	900	1050	1200	1350	1500	1650		
300	5	5	5	5	5	5	5	5	5	5	5	5
450	5	5	5	5	5	5	5	5	5	5	5	5
600	5	5	5	5	5	5	5	5	5	5	5	5
750	5	5	5	5	5	5	5	5	5	5	5	5
900	5	5	5	5	5	5	5	5	5	5	5	5
1050	5	5	5	5	5	5	5	5	5	5	6	6
1200	5	5	5	5	5	5	5	5	6	6	6	6
1350	5	5	5	5	5	5	5	6	6	6	6	6
1500	5	5	5	5	5	5	6	6	6	6	6	8
1650	5	5	5	5	5	6	6	6	6	6	8	8
1800	5	5	5	5	6	6	6	6	6	8	8	8
1950	5	5	5	5	6	6	6	6	6	8	8	8
2100	5	5	5	6	6	6	6	6	6	8	8	8
2250	5	5	5	6	6	6	6	6	6	8	8	8
2400	5	5	5	6	6	6	6	6	6	8	8	10
2550	5	5	5	6	6	6	6	6	6	8	8	10
2700	5	5	5	6	6	6	6	6	6	8	8	10

CORNER												
Table 18 Glass Thickness: Laminated Annealed Glass @ 1200 Pa SLS / 4000 Pa ULS												
Wind Pressure	Edge 1 (mm)											
	300	450	600	750	900	1050	1200	1350	1500	1650		
300	5	5	5	5	5	5	5	5	5	5	5	5
450	5	5	5	5	5	5	5	5	5	5	5	5
600	5	5	5	5	5	5	5	5	5	5	5	5
750	5	5	5	5	5	5	5	5	5	5	6	6
900	5	5	5	5	5	5	5	5	5	6	6	8
1050	5	5	5	5	5	5	5	6	6	6	8	8
1200	5	5	5	5	5	6	6	6	6	6	8	8
1350	5	5	5	5	6	6	6	6	6	6	8	8
1500	5	5	5	5	6	6	6	6	6	6	8	8
1650	5	5	6	6	6	6	6	6	6	6	8	8
1800	5	5	6	6	6	6	6	6	6	6	8	8
1950	5	5	6	6	6	6	6	6	6	6	8	8
2100	5	5	6	6	6	6	6	6	6	6	8	8
2250	5	5	6	6	6	6	6	6	6	6	8	12
2400	5	5	6	6	6	6	6	6	6	6	8	12
2550	5	5	6	6	6	6	6	6	6	6	8	12
2700	5	5	6	6	6	6	6	6	6	6	8	12



GENERAL													
Glass Thickness: Toughened Glass @ 400 Pa SLS / 600 Pa ULS													
Table 21	Wind Pressure	Edge 1 (mm)											
		300	450	600	750	900	1050	1200	1350	1500	1650		
	300	4	4	4	4	4	4	4	4	4	4	4	4
	450	4	4	4	4	4	4	4	4	4	4	4	4
	600	4	4	4	4	4	4	4	4	4	4	4	4
	750	4	4	4	4	4	4	4	4	4	4	4	4
	900	4	4	4	4	4	4	4	4	4	4	4	4
	1050	4	4	4	4	4	4	4	4	4	4	4	4
	1200	4	4	4	4	4	4	4	4	4	4	4	4
	1350	4	4	4	4	4	4	4	4	4	4	4	4
	1500	4	4	4	4	4	4	4	4	4	4	4	4
	1650	4	4	4	4	4	4	4	4	4	4	4	4
	1800	4	4	4	4	4	4	4	4	4	4	4	4
	1950	4	4	4	4	4	4	4	4	4	4	4	4
	2100	4	4	4	4	4	4	4	4	4	4	4	4
	2250	4	4	4	4	4	4	4	4	4	4	4	4
	2400	4	4	4	4	4	4	4	4	4	4	4	4
	2550	4	4	4	4	4	4	4	4	4	4	4	4
	2700	4	4	4	4	4	4	4	4	4	4	4	4
		Edge 2 (mm)											
		N1											

CORNER													
Glass Thickness: Toughened Glass @ 600 Pa SLS / 900 Pa ULS													
Table 21	Wind Pressure	Edge 1 (mm)											
		300	450	600	750	900	1050	1200	1350	1500	1650		
	300	4	4	4	4	4	4	4	4	4	4	4	4
	450	4	4	4	4	4	4	4	4	4	4	4	4
	600	4	4	4	4	4	4	4	4	4	4	4	4
	750	4	4	4	4	4	4	4	4	4	4	4	4
	900	4	4	4	4	4	4	4	4	4	4	4	4
	1050	4	4	4	4	4	4	4	4	4	4	4	4
	1200	4	4	4	4	4	4	4	4	4	4	4	4
	1350	4	4	4	4	4	4	4	4	4	4	4	4
	1500	4	4	4	4	4	4	4	4	4	4	4	4
	1650	4	4	4	4	4	4	4	4	4	4	4	4
	1800	4	4	4	4	4	4	4	4	4	4	4	4
	1950	4	4	4	4	4	4	4	4	4	4	4	4
	2100	4	4	4	4	4	4	4	4	4	4	4	4
	2250	4	4	4	4	4	4	4	4	4	4	4	4
	2400	4	4	4	4	4	4	4	4	4	4	4	4
	2550	4	4	4	4	4	4	4	4	4	4	4	4
	2700	4	4	4	4	4	4	4	4	5	5	5	4
		Edge 2 (mm)											
		N1											

GENERAL													
Glass Thickness: Toughened Glass @ 400 Pa SLS / 900 Pa ULS													
Table 22	Wind Pressure	Edge 1 (mm)											
		300	450	600	750	900	1050	1200	1350	1500	1650		
	300	4	4	4	4	4	4	4	4	4	4	4	4
	450	4	4	4	4	4	4	4	4	4	4	4	4
	600	4	4	4	4	4	4	4	4	4	4	4	4
	750	4	4	4	4	4	4	4	4	4	4	4	4
	900	4	4	4	4	4	4	4	4	4	4	4	4
	1050	4	4	4	4	4	4	4	4	4	4	4	4
	1200	4	4	4	4	4	4	4	4	4	4	4	4
	1350	4	4	4	4	4	4	4	4	4	4	4	4
	1500	4	4	4	4	4	4	4	4	4	4	4	4
	1650	4	4	4	4	4	4	4	4	4	4	4	4
	1800	4	4	4	4	4	4	4	4	4	4	4	4
	1950	4	4	4	4	4	4	4	4	4	4	4	4
	2100	4	4	4	4	4	4	4	4	4	4	4	4
	2250	4	4	4	4	4	4	4	4	4	4	4	4
	2400	4	4	4	4	4	4	4	4	4	4	4	4
	2550	4	4	4	4	4	4	4	4	4	4	4	4
	2700	4	4	4	4	4	4	4	4	4	4	4	4
		Edge 2 (mm)											
		N2											

CORNER													
Glass Thickness: Toughened Glass @ 600 Pa SLS / 1300 Pa ULS													
Table 22	Wind Pressure	Edge 1 (mm)											
		300	450	600	750	900	1050	1200	1350	1500	1650		
	300	4	4	4	4	4	4	4	4	4	4	4	4
	450	4	4	4	4	4	4	4	4	4	4	4	4
	600	4	4	4	4	4	4	4	4	4	4	4	4
	750	4	4	4	4	4	4	4	4	4	4	4	4
	900	4	4	4	4	4	4	4	4	4	4	4	4
	1050	4	4	4	4	4	4	4	4	4	4	4	4
	1200	4	4	4	4	4	4	4	4	4	4	4	4
	1350	4	4	4	4	4	4	4	4	4	4	4	4
	1500	4	4	4	4	4	4	4	4	4	4	4	4
	1650	4	4	4	4	4	4	4	4	4	4	4	4
	1800	4	4	4	4	4	4	4	4	4	4	4	4
	1950	4	4	4	4	4	4	4	4	4	4	4	4
	2100	4	4	4	4	4	4	4	4	4	4	4	4
	2250	4	4	4	4	4	4	4	4	4	4	4	4
	2400	4	4	4	4	4	4	4	4	4	4	4	4
	2550	4	4	4	4	4	4	4	4	4	4	4	4
	2700	4	4	4	4	4	4	4	4	4	5	5	4
		Edge 2 (mm)											
		N2											



GENERAL												
Table 23 Glass Thickness: Toughened Glass @ 600 Pa SLS / 1400 Pa ULS												
Wind Pressure	Edge 1 (mm)											
	300	450	600	750	900	1050	1200	1350	1500	1650		
300	4	4	4	4	4	4	4	4	4	4	4	4
450	4	4	4	4	4	4	4	4	4	4	4	4
600	4	4	4	4	4	4	4	4	4	4	4	4
750	4	4	4	4	4	4	4	4	4	4	4	4
900	4	4	4	4	4	4	4	4	4	4	4	4
1050	4	4	4	4	4	4	4	4	4	4	4	4
1200	4	4	4	4	4	4	4	4	4	4	4	4
1350	4	4	4	4	4	4	4	4	4	4	4	4
1500	4	4	4	4	4	4	4	4	4	4	4	4
1650	4	4	4	4	4	4	4	4	4	4	4	4
1800	4	4	4	4	4	4	4	4	4	4	4	4
1950	4	4	4	4	4	4	4	4	4	4	4	4
2100	4	4	4	4	4	4	4	4	4	4	4	4
2250	4	4	4	4	4	4	4	4	4	4	4	4
2400	4	4	4	4	4	4	4	4	4	4	4	4
2550	4	4	4	4	4	4	4	4	4	4	4	4
2700	4	4	4	4	4	4	4	5	5	5	5	4
Edge 2 (mm)												
N3												

CORNER												
Table 23 Glass Thickness: Toughened Glass @ 800 Pa SLS / 2000 Pa ULS												
Wind Pressure	Edge 1 (mm)											
	300	450	600	750	900	1050	1200	1350	1500	1650		
300	4	4	4	4	4	4	4	4	4	4	4	4
450	4	4	4	4	4	4	4	4	4	4	4	4
600	4	4	4	4	4	4	4	4	4	4	4	4
750	4	4	4	4	4	4	4	4	4	4	4	4
900	4	4	4	4	4	4	4	4	4	4	4	4
1050	4	4	4	4	4	4	4	4	4	4	4	4
1200	4	4	4	4	4	4	4	4	4	4	4	4
1350	4	4	4	4	4	4	4	4	4	4	4	4
1500	4	4	4	4	4	4	4	4	4	4	4	4
1650	4	4	4	4	4	4	4	4	4	4	4	4
1800	4	4	4	4	4	4	4	4	4	4	4	4
1950	4	4	4	4	4	4	4	4	4	4	4	4
2100	4	4	4	4	4	4	4	4	4	4	4	4
2250	4	4	4	4	4	4	4	4	4	4	4	4
2400	4	4	4	4	4	4	4	4	5	5	5	4
2550	4	4	4	4	4	4	4	4	5	5	5	5
2700	4	4	4	4	4	4	4	5	5	5	5	5
Edge 2 (mm)												
N3												

GENERAL												
Table 24 Glass Thickness: Toughened Glass @ 800 Pa SLS / 2000 Pa ULS												
Wind Pressure	Edge 1 (mm)											
	300	450	600	750	900	1050	1200	1350	1500	1650		
300	4	4	4	4	4	4	4	4	4	4	4	4
450	4	4	4	4	4	4	4	4	4	4	4	4
600	4	4	4	4	4	4	4	4	4	4	4	4
750	4	4	4	4	4	4	4	4	4	4	4	4
900	4	4	4	4	4	4	4	4	4	4	4	4
1050	4	4	4	4	4	4	4	4	4	4	4	4
1200	4	4	4	4	4	4	4	4	4	4	4	4
1350	4	4	4	4	4	4	4	4	4	4	4	4
1500	4	4	4	4	4	4	4	4	4	4	4	4
1650	4	4	4	4	4	4	4	4	4	4	4	4
1800	4	4	4	4	4	4	4	4	4	4	4	4
1950	4	4	4	4	4	4	4	4	4	4	4	4
2100	4	4	4	4	4	4	4	4	4	4	4	4
2250	4	4	4	4	4	4	4	4	4	4	4	4
2400	4	4	4	4	4	4	4	4	5	5	5	4
2550	4	4	4	4	4	4	4	4	5	5	5	5
2700	4	4	4	4	4	4	4	5	5	5	5	5
Edge 2 (mm)												
N4												

CORNER												
Table 24 Glass Thickness: Toughened Glass @ 1200 Pa SLS / 3000 Pa ULS												
Wind Pressure	Edge 1 (mm)											
	300	450	600	750	900	1050	1200	1350	1500	1650		
300	4	4	4	4	4	4	4	4	4	4	4	4
450	4	4	4	4	4	4	4	4	4	4	4	4
600	4	4	4	4	4	4	4	4	4	4	4	4
750	4	4	4	4	4	4	4	4	4	4	4	4
900	4	4	4	4	4	4	4	4	4	4	4	4
1050	4	4	4	4	4	4	4	4	4	4	4	4
1200	4	4	4	4	4	4	4	4	4	4	4	4
1350	4	4	4	4	4	4	4	4	4	4	4	4
1500	4	4	4	4	4	4	4	4	4	4	4	4
1650	4	4	4	4	4	4	4	4	4	4	4	4
1800	4	4	4	4	4	4	4	4	4	4	4	4
1950	4	4	4	4	4	4	4	4	4	5	5	4
2100	4	4	4	4	4	4	4	4	4	5	5	5
2250	4	4	4	4	4	4	4	4	4	5	5	5
2400	4	4	4	4	4	4	4	4	4	5	5	5
2550	4	4	4	4	4	4	4	4	4	5	5	5
2700	4	4	4	4	4	4	4	4	4	5	5	5
Edge 2 (mm)												
N4												

CORNER													
Glass Thickness: Toughened Glass @ 1800 Pa SLS / 4500 Pa ULS													
Table 25	Wind Pressure	Edge 1 (mm)											
		300	450	600	750	900	1050	1200	1350	1500	1650		
	300	4	4	4	4	4	4	4	4	4	4	4	4
	450	4	4	4	4	4	4	4	4	4	4	4	4
	600	4	4	4	4	4	4	4	4	4	4	4	4
	750	4	4	4	4	4	4	4	4	4	4	4	4
	900	4	4	4	4	4	4	4	4	4	4	4	5
	1050	4	4	4	4	4	4	4	4	4	4	4	5
	1200	4	4	4	4	4	4	4	4	4	4	5	5
	1350	4	4	4	4	4	4	4	4	4	4	5	5
	1500	4	4	4	4	4	4	4	4	4	4	5	5
	1650	4	4	4	4	4	4	4	4	4	4	5	5
	1800	4	4	4	4	4	4	4	4	4	4	5	5
	1950	4	4	4	4	4	4	4	4	4	4	5	5
	2100	4	4	4	4	4	4	4	4	4	4	5	5
	2250	4	4	4	4	4	4	4	4	4	4	5	5
	2400	4	4	4	4	4	4	4	4	4	4	5	5
	2550	4	4	4	4	4	4	4	4	4	4	5	5
	2700	4	4	4	4	4	4	4	4	4	4	5	5

GENERAL													
Glass Thickness: Toughened Glass @ 1200 Pa SLS / 3000 Pa ULS													
Table 25	Wind Pressure	Edge 1 (mm)											
		300	450	600	750	900	1050	1200	1350	1500	1650		
	300	4	4	4	4	4	4	4	4	4	4	4	4
	450	4	4	4	4	4	4	4	4	4	4	4	4
	600	4	4	4	4	4	4	4	4	4	4	4	4
	750	4	4	4	4	4	4	4	4	4	4	4	4
	900	4	4	4	4	4	4	4	4	4	4	4	4
	1050	4	4	4	4	4	4	4	4	4	4	4	4
	1200	4	4	4	4	4	4	4	4	4	4	4	4
	1350	4	4	4	4	4	4	4	4	4	4	4	4
	1500	4	4	4	4	4	4	4	4	4	4	4	4
	1650	4	4	4	4	4	4	4	4	4	4	4	4
	1800	4	4	4	4	4	4	4	4	4	4	4	4
	1950	4	4	4	4	4	4	4	4	4	4	4	4
	2100	4	4	4	4	4	4	4	4	4	4	4	4
	2250	4	4	4	4	4	4	4	4	4	4	4	4
	2400	4	4	4	4	4	4	4	4	4	4	4	4
	2550	4	4	4	4	4	4	4	4	4	4	4	4
	2700	4	4	4	4	4	4	4	4	4	4	4	4

CORNER													
Glass Thickness: Toughened Glass @ 2500 Pa SLS / 6000 Pa ULS													
Table 26	Wind Pressure	Edge 1 (mm)											
		300	450	600	750	900	1050	1200	1350	1500	1650		
	300	4	4	4	4	4	4	4	4	4	4	4	4
	450	4	4	4	4	4	4	4	4	4	4	4	4
	600	4	4	4	4	4	4	4	4	4	4	4	4
	750	4	4	4	4	4	4	4	4	4	4	4	4
	900	4	4	4	4	4	4	4	4	4	4	4	4
	1050	4	4	4	4	4	4	4	4	4	4	4	4
	1200	4	4	4	4	4	4	4	4	4	4	4	4
	1350	4	4	4	4	4	4	4	4	4	4	4	4
	1500	4	4	4	4	4	4	4	4	4	4	4	4
	1650	4	4	4	4	4	4	4	4	4	4	4	4
	1800	4	4	4	4	4	4	4	4	4	4	4	4
	1950	4	4	4	4	4	4	4	4	4	4	4	4
	2100	4	4	4	4	4	4	4	4	4	4	4	4
	2250	4	4	4	4	4	4	4	4	4	4	4	4
	2400	4	4	4	4	4	4	4	4	4	4	4	4
	2550	4	4	4	4	4	4	4	4	4	4	4	4
	2700	4	4	4	4	4	4	4	4	4	4	4	4

GENERAL													
Glass Thickness: Toughened Glass @ 1600 Pa SLS / 4000 Pa ULS													
Table 26	Wind Pressure	Edge 1 (mm)											
		300	450	600	750	900	1050	1200	1350	1500	1650		
	300	4	4	4	4	4	4	4	4	4	4	4	4
	450	4	4	4	4	4	4	4	4	4	4	4	4
	600	4	4	4	4	4	4	4	4	4	4	4	4
	750	4	4	4	4	4	4	4	4	4	4	4	4
	900	4	4	4	4	4	4	4	4	4	4	4	4
	1050	4	4	4	4	4	4	4	4	4	4	4	4
	1200	4	4	4	4	4	4	4	4	4	4	4	4
	1350	4	4	4	4	4	4	4	4	4	4	4	4
	1500	4	4	4	4	4	4	4	4	4	4	4	4
	1650	4	4	4	4	4	4	4	4	4	4	4	4
	1800	4	4	4	4	4	4	4	4	4	4	4	4
	1950	4	4	4	4	4	4	4	4	4	4	4	4
	2100	4	4	4	4	4	4	4	4	4	4	4	4
	2250	4	4	4	4	4	4	4	4	4	4	4	4
	2400	4	4	4	4	4	4	4	4	4	4	4	4
	2550	4	4	4	4	4	4	4	4	4	4	4	4
	2700	4	4	4	4	4	4	4	4	4	4	4	4

GENERAL												
Table 27 Glass Thickness: Toughened Glass @ 600 Pa SLS / 1800 Pa ULS												
Wind Pressure	Edge 1 (mm)											
	300	450	600	750	900	1050	1200	1350	1500	1650		
300	4	4	4	4	4	4	4	4	4	4	4	4
450	4	4	4	4	4	4	4	4	4	4	4	4
600	4	4	4	4	4	4	4	4	4	4	4	4
750	4	4	4	4	4	4	4	4	4	4	4	4
900	4	4	4	4	4	4	4	4	4	4	4	4
1050	4	4	4	4	4	4	4	4	4	4	4	4
1200	4	4	4	4	4	4	4	4	4	4	4	4
1350	4	4	4	4	4	4	4	4	4	4	4	4
1500	4	4	4	4	4	4	4	4	4	4	4	4
1650	4	4	4	4	4	4	4	4	4	4	4	4
1800	4	4	4	4	4	4	4	4	4	4	4	4
1950	4	4	4	4	4	4	4	4	4	4	4	4
2100	4	4	4	4	4	4	4	4	4	4	4	4
2250	4	4	4	4	4	4	4	4	4	4	4	4
2400	4	4	4	4	4	4	4	4	4	4	4	4
2550	4	4	4	4	4	4	4	4	4	4	4	4
2700	4	4	4	4	4	4	4	4	5	5	5	4
Edge 2 (mm)												

GENERAL												
Table 28 Glass Thickness: Toughened Glass @ 800 Pa SLS / 2700 Pa ULS												
Wind Pressure	Edge 1 (mm)											
	300	450	600	750	900	1050	1200	1350	1500	1650		
300	4	4	4	4	4	4	4	4	4	4	4	4
450	4	4	4	4	4	4	4	4	4	4	4	4
600	4	4	4	4	4	4	4	4	4	4	4	4
750	4	4	4	4	4	4	4	4	4	4	4	4
900	4	4	4	4	4	4	4	4	4	4	4	4
1050	4	4	4	4	4	4	4	4	4	4	4	4
1200	4	4	4	4	4	4	4	4	4	4	4	4
1350	4	4	4	4	4	4	4	4	4	4	4	4
1500	4	4	4	4	4	4	4	4	4	4	4	4
1650	4	4	4	4	4	4	4	4	4	4	4	4
1800	4	4	4	4	4	4	4	4	4	4	4	4
1950	4	4	4	4	4	4	4	4	4	4	4	5
2100	4	4	4	4	4	4	4	4	4	4	5	5
2250	4	4	4	4	4	4	4	4	4	4	5	5
2400	4	4	4	4	4	4	4	4	4	4	5	5
2550	4	4	4	4	4	4	4	4	4	4	5	5
2700	4	4	4	4	4	4	4	4	4	4	5	5
Edge 2 (mm)												

CORNER												
Table 27 Glass Thickness: Toughened Glass @ 800 Pa SLS / 2700 Pa ULS												
Wind Pressure	Edge 1 (mm)											
	300	450	600	750	900	1050	1200	1350	1500	1650		
300	4	4	4	4	4	4	4	4	4	4	4	4
450	4	4	4	4	4	4	4	4	4	4	4	4
600	4	4	4	4	4	4	4	4	4	4	4	4
750	4	4	4	4	4	4	4	4	4	4	4	4
900	4	4	4	4	4	4	4	4	4	4	4	4
1050	4	4	4	4	4	4	4	4	4	4	4	4
1200	4	4	4	4	4	4	4	4	4	4	4	4
1350	4	4	4	4	4	4	4	4	4	4	4	4
1500	4	4	4	4	4	4	4	4	4	4	4	4
1650	4	4	4	4	4	4	4	4	4	4	4	4
1800	4	4	4	4	4	4	4	4	4	4	4	4
1950	4	4	4	4	4	4	4	4	4	4	4	5
2100	4	4	4	4	4	4	4	4	4	4	5	5
2250	4	4	4	4	4	4	4	4	4	4	5	5
2400	4	4	4	4	4	4	4	4	4	4	5	5
2550	4	4	4	4	4	4	4	4	4	4	5	5
2700	4	4	4	4	4	4	4	4	4	4	5	5
Edge 2 (mm)												

CORNER												
Table 28 Glass Thickness: Toughened Glass @ 1200 Pa SLS / 4000 Pa ULS												
Wind Pressure	Edge 1 (mm)											
	300	450	600	750	900	1050	1200	1350	1500	1650		
300	4	4	4	4	4	4	4	4	4	4	4	4
450	4	4	4	4	4	4	4	4	4	4	4	4
600	4	4	4	4	4	4	4	4	4	4	4	4
750	4	4	4	4	4	4	4	4	4	4	4	4
900	4	4	4	4	4	4	4	4	4	4	4	4
1050	4	4	4	4	4	4	4	4	4	4	4	4
1200	4	4	4	4	4	4	4	4	4	4	4	4
1350	4	4	4	4	4	4	4	4	4	4	4	5
1500	4	4	4	4	4	4	4	4	4	4	5	5
1650	4	4	4	4	4	4	4	4	4	4	5	5
1800	4	4	4	4	4	4	4	4	4	4	5	5
1950	4	4	4	4	4	4	4	4	4	4	5	5
2100	4	4	4	4	4	4	4	4	4	4	5	6
2250	4	4	4	4	4	4	4	4	4	4	5	6
2400	4	4	4	4	4	4	4	4	4	4	5	6
2550	4	4	4	4	4	4	4	4	4	4	5	6
2700	4	4	4	4	4	4	4	4	4	4	5	6
Edge 2 (mm)												

CORNER													
Glass Thickness: Toughened Glass @ 1800 Pa SLS / 5900 Pa ULS													
Table 29	Wind Pressure	Edge 1 (mm)											
		300	450	600	750	900	1050	1200	1350	1500	1650		
	300	4	4	4	4	4	4	4	4	4	4	4	4
	450	4	4	4	4	4	4	4	4	4	4	4	4
	600	4	4	4	4	4	4	4	4	4	4	4	4
	750	4	4	4	4	4	4	4	4	4	4	4	4
	900	4	4	4	4	4	4	4	4	4	4	5	5
	1050	4	4	4	4	4	4	4	4	4	5	5	5
	1200	4	4	4	4	4	4	4	4	5	5	5	6
	1350	4	4	4	4	4	4	4	5	5	5	6	6
	1500	4	4	4	4	4	5	5	5	5	6	6	6
	1650	4	4	4	4	4	5	5	5	6	6	6	6
	1800	4	4	5	5	5	5	5	5	6	6	6	8
	1950	4	4	5	5	5	5	6	6	6	6	8	8
	2100	4	4	5	5	5	5	6	6	8	8	8	8
	2250	4	4	5	5	5	6	6	6	8	8	8	8
	2400	4	4	5	6	6	6	6	8	8	8	8	8
	2550	4	4	5	6	6	6	6	8	8	8	8	8
	2700	4	4	5	6	8	8	8	8	8	8	8	8

GENERAL													
Glass Thickness: Toughened Glass @ 1200 Pa SLS / 4000 Pa ULS													
Table 29	Wind Pressure	Edge 1 (mm)											
		300	450	600	750	900	1050	1200	1350	1500	1650		
	300	4	4	4	4	4	4	4	4	4	4	4	4
	450	4	4	4	4	4	4	4	4	4	4	4	4
	600	4	4	4	4	4	4	4	4	4	4	4	4
	750	4	4	4	4	4	4	4	4	4	4	4	4
	900	4	4	4	4	4	4	4	4	4	4	4	4
	1050	4	4	4	4	4	4	4	4	4	4	4	4
	1200	4	4	4	4	4	4	4	4	4	4	4	4
	1350	4	4	4	4	4	4	4	4	4	4	5	5
	1500	4	4	4	4	4	4	4	4	4	5	5	5
	1650	4	4	4	4	4	4	4	4	5	5	5	5
	1800	4	4	4	4	4	4	4	5	5	5	5	5
	1950	4	4	4	4	4	5	5	5	5	5	6	6
	2100	4	4	4	4	5	5	5	5	5	6	6	6
	2250	4	4	4	5	5	5	5	5	5	6	6	6
	2400	4	4	4	5	5	5	5	5	6	6	6	6
	2550	4	4	4	5	5	5	6	6	6	6	6	6
	2700	4	4	4	5	5	6	6	6	6	6	6	8

CORNER													
Glass Thickness: Toughened Glass @ 2500 Pa SLS / 8000 Pa ULS													
Table 30	Wind Pressure	Edge 1 (mm)											
		300	450	600	750	900	1050	1200	1350	1500	1650		
	300	4	4	4	4	4	4	4	4	4	4	4	4
	450	4	4	4	4	4	4	4	4	4	4	4	4
	600	4	4	4	4	4	4	4	4	4	4	4	5
	750	4	4	4	4	4	4	4	4	5	5	5	5
	900	4	4	4	4	4	4	4	5	5	5	6	6
	1050	4	4	4	4	4	5	5	5	5	6	6	6
	1200	4	4	4	5	5	5	5	6	6	6	8	8
	1350	4	4	4	5	5	6	6	6	6	8	8	8
	1500	4	4	4	5	6	6	6	8	8	8	8	8
	1650	4	4	5	5	6	6	8	8	8	8	8	8
	1800	4	4	5	5	6	8	8	8	8	8	8	8
	1950	4	4	5	6	6	8	8	8	8	8	8	8
	2100	4	4	5	6	6	8	8	8	10	10	10	10
	2250	4	4	5	6	6	8	8	8	10	10	10	10
	2400	4	5	5	8	8	8	8	8	10	10	10	10
	2550	4	5	5	8	8	8	8	8	10	10	10	10
	2700	4	5	5	8	8	8	8	8	10	10	10	10

GENERAL													
Glass Thickness: Toughened Glass @ 1600 Pa SLS / 5300 Pa ULS													
Table 30	Wind Pressure	Edge 1 (mm)											
		300	450	600	750	900	1050	1200	1350	1500	1650		
	300	4	4	4	4	4	4	4	4	4	4	4	4
	450	4	4	4	4	4	4	4	4	4	4	4	4
	600	4	4	4	4	4	4	4	4	4	4	4	4
	750	4	4	4	4	4	4	4	4	4	4	4	4
	900	4	4	4	4	4	4	4	4	4	4	4	4
	1050	4	4	4	4	4	4	4	4	4	5	5	5
	1200	4	4	4	4	4	4	4	5	5	5	5	5
	1350	4	4	4	4	4	4	5	5	5	5	5	5
	1500	4	4	4	4	4	5	5	5	5	6	6	6
	1650	4	4	4	4	4	5	5	5	6	6	6	6
	1800	4	4	4	4	5	5	5	6	6	6	6	6
	1950	4	4	4	5	5	6	6	6	6	8	8	8
	2100	4	4	4	5	5	6	6	6	8	8	8	8
	2250	4	4	4	5	5	6	6	6	8	8	8	8
	2400	4	4	4	5	5	6	6	8	8	8	8	8
	2550	4	4	4	5	6	6	6	8	8	8	8	8
	2700	4	4	5	5	6	6	6	8	8	8	8	8

# APPENDIX B: REFERENCED DOCUMENTS

- AS 1288 Glass in Buildings - Selection and Installation
- AS/NZS 2208 Safety Glazing Materials in Buildings
- AS 3959 Construction of Buildings in Bushfire-Prone Areas
- AS/NZS 4666 Insulating Glass Units
- AS/NZS 4667 Quality Requirement for Cut-To-Size and Processed Glass
- AS/NZS 4668 Glossary of Terms Used in the Glass and Glazing Industry
- AS 2047 Windows and External Glazed Doors in Buildings
- AS/NZS 1170.0 Structural Design Actions Part 0: General Principles
- AS/NZS 1170.1 Structural Design Actions Part 1: Permanent, Imposed and Other Actions
- AS/NZS 1170.2 Structural Design Actions Part 2: Wind Actions
- AS/NZS 1170.3 Structural Design Actions Part 3: Snow and Ice Actions
- AS 4055 Wind Loads for Housing
- AS 1926.1 Swimming Pool Safety Part 1: Fencing for Swimming Pools
- AS 1926.2 Swimming Pool Safety Part 2: Location of Fencing for Private Swimming Pools
- AS/NZS 2107 Acoustics - Recommended Design Sound Levels and Reverberation Times for Building Interiors

# APPENDIX C: GLOSSARY OF TERMS

## A

### Acoustics

The science of sound and sound control.

### Acrylic

A thermoplastic with good weather resistance, shatter resistance and optical clarity, used for glazing.

### Adhesion

The property of a coating or sealant to bond to the surface to which it is applied.

### Adhesive Failure

Loss of bond of a coating or sealant from the surface to which it was applied.

### Air Gap, Airgap

Air space between the panes of glass in an insulating glass unit (IGU). Also known as cavity, airspace or spacer width, even when another gas (for example, argon) is used in the cavity instead of air.

### Air Infiltration

Term used to describe one of the tests required by AS 2047. The window shall not exceed air leakage requirements as specified for either air conditioned buildings or non-air conditioned buildings.

### Annealed Glass

Also known as float glass. Glass which is cooled gradually during manufacture in an annealing operation to reduce residual stresses and strains which can be produced during cooling. This is the ordinary glass used in windows.

### Argon

An inert, non-toxic gas used in insulating windows to reduce heat transfer.

### Arrissed Edge

The result of removing sharp edges.

### Australian Fenestration Rating Council (AFRC)

An Australian non-profit organisation that administers the independent rating and labelling system for the energy performance of windows, doors, skylights and attachment products. The AFRC protocols and procedures are regulated through the NCC.

## B

### Backer Rod

Polyethylene or polyurethane foam material installed under compression and used to control sealant joint depth, provide a surface for sealant tooling, serve as a bond breaker to prevent three-sided adhesion and provide an hour-glass contour of the finished bead.

### Bead

A strip of wood, metal, sealant or other suitable material secured to the rebate to retain the glass. Also known as glazing bead or sealant bead. Can be aluminium, timber, rigid PVC or flexible PVC.

### Bed or Bedding

The glazing material used to seal between the glass and frame/bead.

### Bite

Dimension by which the framing system overlaps the edge of the glazing infill.

### Bleeding

Migration of a liquid to the surface of a component or into/onto an adjacent material.

### Body-Tinted Glass

Transparent float glass with a consistent colour throughout its depth.

### Butt-Joined Glazing

Installation of glass products where two or more pieces of glass within a single frame are either butt (or mitre) jointed with the exposed glass edges weather sealed by use of a mastic sealant or adhesive to provide a continuous glazed area. Commonly, these glazing variants are either 180 degree (for example, in a straight line) or form a 90 degree corner, but may include any angle, and may be either vertical or horizontal.

## C

### Caulk

Compound/sealant used for sealing that has minimum joint movement capability; sometimes called low performance sealant.

### Cavity

Space between the panes of glass in an insulating glass unit (IGU) (see also Air Gap).

### Channel

(See Glazing Channel.)

### Channel Depth

The measurement from the bottom of the channel to the top, or measurement from sight line to base of channel.

### Chip

A small piece of glass that has become detached from the surface or edge.

### Chipped Edge

Imperfection due to breakage of a small fragment from the cut edge of the glass. Generally this is not serious except in heat-absorbing glass.

### Compatibility

Ability of two or more materials to exist in close and permanent association for an indefinite period with no adverse effect of one upon the other.

### Compound

Chemical formulation of ingredients used to produce a caulking, elastomeric joint sealant, etc.

### Condensation

Formation of water droplets on the surface of an object caused by warm moist air coming into contact with a cold object whose surface temperature is below the Dew Point.

### Conduction

Heat transfer through a solid material by contact of one molecule to the next. Heat flows from a higher temperature area to a lower temperature one.

### Convection

A heat transfer process involving motion in a fluid (such as air) caused by the difference in density of the fluid and the action of gravity. Convection affects heat transfer from the glass surface to room air and between two panes of glass.

### Curtain Wall

A non-load-bearing window wall that is not a panel wall.

## D

### Daylight Opening

The clear daylight size that is visible through a glazed window pane.

### Daylight Transmittance

Ratio of the amount of light transmitted through a window system (glass frame) divided by the amount of light incident on its outside surface. Synonymous with Visible Transmittance.

### Deflection (Centre of Glass)

Amount of bending movement of the centre of a glass panel perpendicular to the plane of the glass surface under an applied load.

### Deflection (Framing Member)

The amount of bending movement of any part of a structural member perpendicular to the axis of the member under an applied load.

### Deflection Ratio

Given a specified wind load, the live load deflection of the length (L) of a framing member is limited to L/250 of its span.

### Desiccant

Dehydrating agent within hollow spacer frames to absorb moisture from air within insulating glass units (IGUs).

### Dew Point

Temperature at which water vapour condenses when warm, moist air is cooled.

### Door

A hinged, sliding or otherwise supported openable barrier providing entrance to and exit from a building, corridor or room. Doors may be framed or unframed.

### Double-Glazed Unit

Two panes of glass separated by an air or gas space to improve insulation against heat transfer and/or sound transmission. The air between the glass sheets is dried and the space is sealed, eliminating possible condensation and providing superior insulating properties.

### Drainage Slots

(See Weep Holes.)

### Dry seal

A weather seal between the glass and frame using foam tapes or gasket materials.

**NOTE:** A dry seal may not be completely watertight.

### Durometer

Measurement of hardness of a material (see Shore 'A' Hardness). A gauge to measure the hardness of an elastomeric material.

## E

### Edge Cover

The distance between the edge of the glass and the sight line.

### Edge Clearance

Nominal spacing between the edge of the glass product and the bottom of the glazing pocket (channel).

### Edge Defects

Glass defects that include vents, shells, flakes, chips, wave, shark's teeth, nibs and corners on/off.

### Edge Effects

Two dimensional heat transfer at the edge of a glazing unit due to the thermal properties of spacers and sealants.

### Edge Seal

Seal around the perimeter edge of an insulating glass unit (IGU) and the panes of glass.

### Elastomeric

(adj.) Having the property of returning to its original shape and position after removal of load; (n.) An elastic rubber-like substance.

### Emissivity

(See Emittance.)

### **Emittance**

Measures the ability of a surface to emit long-wave infrared radiation, compared with the emittance of a 'perfect black body', equal to 1.0. The emittance of uncoated, clear glass is 0.84. A very good Low-Emittance coating will have an emittance of 0.5 or less.

### **Etch**

To alter the surface of glass with hydrofluoric acid or other caustic agents. Permanent etching of glass may occur from alkali and other runoff from surrounding building materials.

### **Ethylene Propylene Diene Monomer (EPDM)**

A synthetic rubber.

### **External Glaze**

A design which permits the glass to be glazed from outside the building.

### **Exposed Edge**

A glass edge that is not covered.

**NOTE:** Glass with exposed edges has no protection from damage and may cause injury to those who come in contact with it.

## **F**

### **Factory Glaze**

Windows that are glazed in the factory before delivery to site.

### **Fenestration**

The arrangement of windows and other openings on the external walls of buildings, especially the façade.

### **Fin**

A piece of glass positioned such as to provide lateral support.

### **Finished Floor Level (FFL)**

The position of the finished floor level in buildings.

### **Fixed Lite**

An area of window where the glass cannot be opened.

### **Fixing**

Any item that is used to secure members of a window assembly to each other, to secure an item of hardware to a window member or to secure a completed window assembly into the building structure.

### **Fixture**

An area where the glass or panel cannot be opened for ventilation.

### **Flanking**

The mechanism of sound passing from one space to another. Flanking is the transfer of noise through paths around a building element rather than through the building element material directly.

### **Float Glass**

Glass formed on a bath of molten tin. The two surfaces are flat, parallel and polished, giving clear, undistorted vision and reflection.

### **Fogging**

A deposit of contamination left on the inside surface of a sealed insulating glass unit (IGU) due to extremes of temperatures or failed seals.

### **Frame**

A support structure consisting of head, jambs and sill to form an opening into which glazing or door panels fit.

### **Frequency**

All sounds can be described by their frequency or their mix of frequencies. Sounds have a mix of frequencies that is peculiar to the nature of the sound generator. For example, the sound of a tiny bell has a mix of predominantly high frequencies and the sound of a bass drum or large truck has a mix of predominantly lower frequencies. Frequency can be measured on a scale in units of Hertz (Hz).

## **G**

### **Gas Fill**

A process in which argon or krypton is filled into the cavity of insulating glass to improve thermal performance.

### **Gaskets**

Pre-formed shapes (for example, strips) of rubber or rubber-like composition used to fill and seal a joint or opening alone or in conjunction with a supplemental application of a sealant.

### **Gas Fill**

The use of gases other than air (such as argon, krypton, xenon, etc.) in a sealed insulating glazing unit (IGU), for the purpose of reducing conductive/convective heat transfer.

### **Glass**

Hard brittle substance, usually transparent, made by fusing sand, limestone and soda ash under high temperature.

### **Glazing Bar**

A member that is added to a standard window construction to change the appearance of the window. It can be in the form in which the glass is glazed, clipped or stuck onto either or both faces of the glass.

### **Glazing Bead**

Strip or trim surrounding the edge of the glass in a window or door that holds the glass in place.

### **Glazing Channel**

Three-sided, U-shaped detail into which a glass product is installed and retained.

### **Glazing Leg**

The portion of the window section which is used to retain the glass in conjunction with the bead.

### **Glazing Rebate**



Part of a frame, the cross-section of which forms an angle into which the edge of glass is glazed.

### Glazing Tape

Glazing tape is the material used on the glazing leg to seal the glass against. Can be a foam tape or similar.

## H

### Hardware

Equipment used in the opening, operating, closing, locking and stopping of sashes.

### Head

All horizontal members at the top of the window frame.

### Heat-Absorption Glass

Glass which absorbs more solar energy than clear float glass.

### Heat Gain

Solar radiant heat, transmitted or emitted by glazing into a building, contributing to the building up of heat.

### Heat Loss

The transfer of heat from inside to outside by means of conduction, convection and radiation through all surfaces of a house.

### Heat-Strengthened Glass

Heat-strengthened glass is approximately twice as strong as annealed glass of the same thickness when exposed to uniform static pressure loads. It is not considered safety glass, but is usually specified where thermal stresses are high.

### High Rise

A multi-storey building.

## I

### Infiltration

The movement of outdoor air into the interior of a building through cracks around windows and doors or in walls, roofs and floors.

### Installation

Erection and fixing of window frame on site.

### Insulating Glass Unit (IGU)

A hermetically sealed, multiple-pane glazing system consisting of two or more glazing layers held and bonded at their perimeter by a spacer bar. Termed 'insulating' because thermal heat transfer is reduced compared with single glass.

### Insulation

Construction materials used for protection from noise, heat, cold or fire.

### Interlayer

Any material used to bond two panes of glass and/or plastic together to form laminated glass.

### Internal Glaze

A design which permits the glass to be glazed from inside the building.

## J

### Jamb

Sides of a window frame.

### Joint

Space or opening between two or more adjoining surfaces.

## K

### Krypton

An inert, non-toxic gas used in insulating windows to reduce heat transfer.

## L

### Laminated Glass

Two or more layers of glass permanently bonded with one or more polymer interlayers to form single, unified glazing with improved safety and/or ultra violet protection properties.

### Lapped Glass

A permanent vent window which has two panes of glass overlapping to allow ventilation and weatherproofing.

### Left Hand

To describe a component or design. Always taken viewing the window from the outside.

### Light

Electromagnetic radiation (solar or artificial) which is visible to the human eye. Invisible radiation (for example, UV or infrared) should not be called 'light'.

### Light

Alternative term for a pane of glass.

### Live Load

Loads produced by the use and occupancy of the building or other structure and do not include construction or environmental loads such as wind load, snow load, ice load, rain load, seismic load or dead load.

### Low-E (Low Emissivity) Coating

A thin (<100 nm thick) metal, metal oxide or multilayer coating deposited on a glazing surface to reduce its thermal infrared emittance and thereby reduce radiative heat transfer. Near-infrared transmittance may also be reduced depending on whether solar heat is to be rejected or admitted. All Low-E coatings behave as heat mirrors. A Low-E coating increases a window's ability to insulate (lower U-value).

### Low-E Glass

Low-Emissivity glass (Low-E) is a clear glass that has a microscopically thin coating of metal oxide. This allows the sun's heat and light to pass through the glass into the building. At the same time, it blocks heat from leaving the room, reducing the loss considerably.

### Low Lite

The portion of the window that is below the transom.

## M

### Mastic

Descriptive of heavy-consistency compounds that may remain adhesive and pliable with age.

### Micron

Measurement of length, often used for the wavelength of light. Equal to  $10^{-6}$  metres. Under the System Internationale (SI) system of units, usage of the term 'micrometre' is preferred.

### Migration

Spreading or creeping of a constituent of a compound onto/into adjacent surfaces (see also Bleeding).

## N

### National Fenestration Rating Council (NFRC)

A non-profit organisation in the United States that administers the independent rating and labelling system for the energy performance of windows, doors, skylights and attachment products.

### Neoprene

Synthetic rubber having physical properties closely resembling those of natural rubber. Made by polymerising chloroprenes. The latter compounds are produced from acetylene and hydrogen chloride.

### Newton

The force which, when applied to a body having a mass of one kilogram, causes an acceleration of one metre per second squared in the direction of application of the force.

### Nickel Sulphide Inclusion

A rare, but naturally occurring impurity present in all glass that can, in certain

circumstances, lead to spontaneous breakage of thermally toughened glass in service.

### Normal

Direction at right angles to a surface.

## O

### Obscure Glass

Any textured glass (frosted, etched, fluted, ground, etc.) used for privacy, light diffusion or decorative effects.

### Off-Line Coatings

In this process a coating is applied under a vacuum to finished cold glass.

### On-Line Coatings

The process in which coatings are directly applied to the glass during production while the glass is still hot in the annealing lehr.

### Operable Window

Window that can be opened for ventilation.

## P

### Pane

Framed sheet of glass.

### Pascal (Pa)

The pressure or stress that arises when a force of one newton is applied uniformly over an area of one square metre.

### Passive-Solar Gain

Direct admittance of solar heat to a building (usually in winter and deliberately) via equator-facing windows, to reduce or eliminate bought heating energy.

### Plastic Film

A thin plastic substrate, sometimes used as the inner layers in a triple or quadruple-glazed window.

### Plastics

Artificial substances made of organic polymers that can be extruded or moulded into various shapes including window frames and sashes.

### Plate Glass

Previously used to produce higher quality glass, this technology was completely outperformed by the float glass process.

### Polyisobutylene

Typically the primary seal in a dual-seal Insulating Glass Unit (IGU) and the key component in restricting moisture vapour transmission.

### Polysulphide Sealant

Polysulphide liquid polymer sealant which are mercaptan-terminated, long-chain aliphatic polymers containing disulphide linkages. Can be converted to rubbers at room temperature without shrinkage upon addition of a curing agent.

### Polyurethane Sealant

Organic compound formed by the reaction of a glycol with an isocyanate.

### Polyvinyl Butyral (PVB)

The plastic interlayer incorporated into laminated glass in order to ensure good adhesion and the mechanical and safety breakage characteristic of the glass.

### Primer

Coating specifically designed to enhance the adhesion of sealant systems to certain surfaces, to form a barrier to prevent migration of components, or to seal a porous substrate.

### Priming

Sealing of a porous surface so that it will not stain, lose elasticity, shrink excessively, etc., because of loss of oil or similar into the surrounds. A sealant primer or surface conditioner may be used to promote adhesion of a curing-type sealant to certain surfaces.

## R

### **Rebate**

(See Glazing Rebate.)

### **Reflectance**

The ratio of reflected radiant energy to incident radiant energy.

### **Reflective Glass**

Glass with a metallic coating to reduce solar heat gain (see also Solar Control Glass).

### **Refraction**

The deflection of a light ray from a straight path when it passes at an oblique angle from one medium (such as air) to another (such as glass).

### **Relative Humidity**

Air humidity expressed as a percentage of the maximum possible humidity at a given temperature. Percentage of moisture in the air in relationship to the amount of moisture the air could hold at that given temperature. At 100 per cent relative humidity, moisture condenses and falls as rain.

### **Retrofitting**

Adding or replacing items on existing buildings. Typical retrofit products are replacement doors and windows, insulation, storm windows, caulking, weatherstripping and vents.

### **Right Hand**

Describing a component or design. Always taken viewing the window from the outside.

## S

### **Safety Glass**

Glass constructed, treated or combined with other materials in order to reduce the likelihood of injuries if broken by human impact, etc., that meets the relevant safety standards. Safety glass comprises toughened, laminated and

wired glass.

### **Sash**

Inner frame that holds glass in operable and fixed window units.

### **Scratches**

Any marking or tearing of the surface appearing as though it had been done by either a sharp or rough instrument.

### **Seal**

Accomplishment of weather-tight protection between glazing or framing materials, usually by combinations of gaskets and sealant.

### **Sealant**

Elastomeric material with adhesive qualities applied between components of a similar or dissimilar nature to provide an effective barrier against the passage of the elements.

### **Sealed Unit**

(See Insulating Glass Unit.)

### **Setting Block**

Strip of resilient non-absorbent material (for example, neoprene) used under heavy panes of glass or insulating glass units. Two setting blocks are normally used, which support the glass and centralise it in the frame to prevent glass-to-frame contact or shear forces that might act to break the seal in an Insulated Glass Unit (IGU). The size of the setting block is calculated in relation to the thickness and weight of the glass.

### **Sheet Glass**

A transparent, flat glass found in older windows, now largely replaced by float glass.

### **Shims**

(See Spacer.)

### **Shore 'A' Hardness**

Measure of firmness of a compound by means of a Durometer Hardness

Gauge. (A hardness range of 20-25 is about the firmness of an art gum eraser. A hardness of 90 is about the firmness of a rubber heel.)

### **Sight Size**

The actual size of the opening that admits daylight.

### **Silicone Sealant**

Sealant having a backbone of alternating silicon-oxygen atoms as its chemical composition.

### **Sill**

Horizontal member at the bottom of a window frame or door.

### **Single Glazing**

Single thickness of glass in a window or door.

### **Site Glaze**

Window glazed after installation of window into building.

### **Soft Coat(ing)**

Generally refers to silver-based Low-E coating (see also Low-E Coating). So-called due to its susceptibility to damage through abrasion. Generally a multilayer structure of alternate dielectric and thin transparent metal layers.

### **Solar Absorptance**

Fraction of incident solar radiation energy absorbed by the glazing.

### **Solar Control Glass**

Tinted and/or coated glass that reduces the amount of solar heat gain transmitted into building.

### **Solar Heat Gain Coefficient (SHGC)**

The total solar heat gain divided by exterior solar irradiance. Composed of the solar direct transmittance plus the inward-flowing fraction of absorbed solar energy that is re-radiated, conducted or convected into the

space. Also known as the Total Solar Energy Transmittance (TSET) or g-value (European usage). For example, clear 3 mm glass has a SHGC of 0.87.

### Solar Transmittance

Fraction of direct-beam solar radiation energy transmitted by a glazing system. Does not include the inward-flowing fraction of the absorbed solar irradiance.

### Sound Transmission Class (STC)

The sound transmission loss rating of a material over a selected range of sound frequencies. The higher the number, the less sound transmitted.

### Spacer Frame

Component of an Insulating Glass Unit (IGU) which maintains the width of space between the panes of the unit (see also Air Gap).

### Spacers (Shims)

Small blocks of neoprene, Ethylene Propylene Diene Monomer (EPDM), silicone or other suitable material, placed on each side of the glass product to provide glass centring, maintain uniform width of sealant bead and prevent excessive sealant distortion.

### Spandrel

Panel(s) of a wall located between vision areas of windows that conceal structural columns and floors.

### Spectrally Selective Coating

A Low-E coating, on one or more surfaces of a glazing, whose optical properties vary with wavelength, to transmit visible radiation more than near-infrared and longwave radiation.

### Staining

Discolouration of either glass or framing material surface caused by alkalis that leach from surrounding materials such as concrete, sealant, pollutants or other contaminants.

### Stile (Sash)

A vertical side member of a sash.

### Stress (Residual)

Any condition of tension or compression existing within the glass, particularly due to incomplete annealing, temperature gradient or inhomogeneity.

### Structural Members

The elements, including mullions, transoms, meeting rails and meeting stiles that perform the function of transferring loads to the perimeter frame.

**Note:** Glazing bars, awning and casement sash stiles and rails are not considered structural.

### Structural Silicone Glazing

Use of a silicone sealant for the structural transfer of loads from the glass to its perimeter support system and retention of the glass in the opening.

### System Internationale (SI)

The international measurement system of metric units used in Australia.

## T

### Tape Sealant

Sealant having a pre-formed shape and intended to be used in a joint under compression.

### Tempered Glass

(See Toughened Glass.)

### Test Report

A report issued by a test laboratory detailing the tests that a window has undergone.

### Thermal Expansion

Change in dimension of a material as a result of temperature change.

### Thermal Stress/Failure

Where an area of glass directly exposed to solar radiation absorbs heat, rises in temperature and expands. The edges of glass shielded from the solar radiation by framing, etc., remain cooler than the unshielded area. The resulting differential expansion causes stress, which will, should it reach the breaking stress of the glass, result in fracture.

### Tinted Glass

Glass with colourants (pigments) added to the basic glass batch that gives the glass colour, as well as light and heat-absorbing capabilities. The colour extends throughout the thickness of the glass. Often referred to as body-tinted glass.

### Toned Glass

Alternative name for tinted glass.

### Toughened Glass

Flat or bent glass that has been heat treated and quickly air-quenched to create compression in the outer surface and tension in the interior. If broken, it fractures into many small pieces. Toughened glass is approximately four to five times stronger than annealed glass of the same thickness when exposed to uniform static pressure loads and is classified as a safety glass.

### Transmittance

The percentage of radiation that can pass through glazing. Transmittance can be defined for different types of light or energy, for example, visible light transmittance, UV transmittance or total solar energy transmittance.

### Transom

A horizontal intermediate framing member of a window assembly.

### Triple Glazing

Three panes of glass or plastic with two air spaces between.

### Two-Part (Multi-Component) Sealant

Product comprised of a base and curing agent or accelerator, necessarily

packaged in two separate containers which are uniformly mixed just prior to use.

## U

### Ultraviolet Radiation (UV)

Electromagnetic radiation from the sun, with wavelengths shorter than visible light (i.e. below 380 nanometres).

### Unglazed

Window supplied ex factory without the glass.

### Unit

Term normally used to refer to one single assembly of an Insulating Glass Unit (IGU).

### U-Value (Total)

Area-weighted average thermal transmittance of a complete window, including centre-of-glass, edge-of-glass and frame U-values.

### U-Value

Rate of heat flow through a window or other building element, driven by a temperature difference across the element. Measured as heat flow per unit area, per degree of temperature difference. Also called the thermal transmittance or overall heat transfer coefficient. Reciprocal of thermal resistance:  $U = 1/R$ .

## V

### Visible Face

Applies to extrusions and describes the visible area remaining on the section when the section is assembled into a window.

### Visible Transmittance

Fraction of visible radiation transmitted by a glazing system between the limits of 380 and 770 nm (0.38-0.77  $\mu\text{m}$  (micron, micrometre)). Weighted according to the photopic response of the human eye (V-lambda curve).

### Visual Comfort

Refers to a set of qualities associated with the amenity of a window, such as freedom from glare and excessive contrast.

### Visible Light

The portion of the electromagnetic spectrum that produces light that can be seen. Wave-lengths range from 380 to 720 nanometres.

## W

### Water Penetration

A term used to describe the water performance of a window. Part of the standard testing procedure on a window calls for a water test. A window cannot have water penetrate beyond the inner face after a 15 minute water test at a specified wind pressure. Minimum pressure is 150 Pa up to a maximum of 450 Pa.

### Weather Seal

A material included in a window assembly to reduce the air infiltration or improve resistance to water penetration.

### Weathering

(See also Staining.) Attack of a glass surface by atmospheric elements.

### Wedges

Wood (or metal) wedges used to secure the window or door unit in the rough opening in a plumb, level and square position during and after installation.

### Weep Holes

(See also Drainage Slots.) Drain holes or slots in a sash or framing member to prevent accumulation of condensation and water.

### Wind

Displacement of parallel members with respect to one another.

### Wind Classification

The serviceability wind pressure in Pascals that when applied to the window will give the deflection and water penetration requirements of AS 2047.

### Wind Load

The wind pressure in Pascals that the window has to meet. Wind load varies according to location and exposure.

### Window Assembly

A complete unit comprising frame, couplings, sashes, glazing infill panels and hardware.

### Window Hardware

Various devices and mechanisms for the window including catches, fasteners and locks, hinges, pivots, lifts and pulls, pulleys and sash weights, sash balances and stays. Window Wall

Series of multi-light windows, generally from floor to ceiling and often continuous horizontally.

### Wired Glass

Patterned glass having a layer of meshed or stranded wire completely embedded as close as possible to the centre of its thickness during manufacture. The wire restrains the fragments from falling out of a frame when broken.

## Z

### Zenith

The point in the sky directly overhead.

# LIST OF IMAGES AND TABLES

i	Murray Art Museum (MAMA) Source: DLG Aluminium & Glazing	12	Figure 10 Australian Wind Regions Source: AS/NZS 1170.2		Source: Australian Glass and Window Association
ii	Castle Circuit, Seaforth, NSW Source: Evolution Window Systems	12	Figure 11 Terrain Category 1: Enclosed Water Surfaces Photographer: Chris Clarke	20	Figure 20 Low Level Glazing and Full Height Windows Source: G.James
vi	Agnew Street, Norman Park, QLD Source: Bretts Architectural Window Solutions	12	Figure 12 Terrain Category 2: Open Water and Oceans Photographer: Gary Tindale	21	Figure 21 Shopfront Glazing Source: Viridian
1	Figure 1 Glass Composition Source: Shutterstock	12	Figure 13 Terrain Category 3: Suburban Housing Source: Shutterstock	22	Double Exposure of Contemporary Office Interior Source: Shutterstock
2	Window Profile Source: Shutterstock	12	Figure 14 Terrain Category 4: City Centre Source: Shutterstock	23	Figure 22 Sloped Overhead Glazing Source: Shutterstock
3	Figure 2 Float Glass Process Source: Australian Glass and Window Association	13	Figure 15 Topographic Class Source: Australian Glass and Window Association	24	Pole House, Fairhaven, VIC Bradford Glass and Aluminium
4	Figure 3 A Range of Glass Tints and Tones Source: Shutterstock	13	Table 1 AS 4055 Topographic Class Definitions Source: AS 4055	25	Figure 23 Balustrade Designs Not Covered by AS 1288 Source: Hanlon Windows (top), Evolution Window Systems (middle), Vision 3 Window Systems (bottom)
4	Figure 4 A Selection of Decorative Glass Types Source: Glass Block Constructions (top), Shutterstock (bottom)	14	Figure 16 No Shielding Source: Australian Glass and Window Association	26	Modern Shopfront Source: Shutterstock
5	Figure 5 Low-E Glazing Source: Australian Glass and Window Association	15	Griffith Street, Port Fairy, VIC Source: Portland Aluminium and Glass	27	Figure 24 Framed, Unframed and Partly Framed Glazing Source: Shutterstock
5	Figure 6 Insulating Glass Units Source: Shutterstock	16	Kids Can't Fly Source: Australian Glass and Window Association	28	Square Shower, Bleakhouse Road Source: Viridian
6	Figure 7 Toughened Glass Source: Shutterstock	17	Figure 17 Manifestation Source: Shutterstock	29	Figure 25 Glazed Shower Screens Source: Viridian
7	Figure 8 Laminated Glass Source: Australian Glass and Window Association	18	Figure 18 Human Impact Critical Locations Source: AS 1288 and Australian Glass and Window Association	30	The Sisters Estate, Sorrento, VIC Source: European Window Co
10	Cyclonic Winds Source: Shutterstock	19	Figure 19 Manifestation Recommendations	32	Figure 26 Energy Efficiency of a Window Source: Australian Glass and Window Association
11	Figure 9 Storm Over the Gold Coast, 2010 Photographer: Paul Bica			33	Figure 27 The Sun's Path During

	Different Seasons Source: Australian Glass and Window Association	Source: Australian Glass and Window Association	
34	Figure 28 Condensation on a Window Source: Australian Glass and Window Association	43	BAL 29 and BAL 40 Windows used in Righetti Lane Project, Yandoit, VIC Source: Stegbar
34	Figure 29 How Condensation Occurs Source: Australian Glass and Window Association	44	Window Installation with a Vacuum Lift Source: Shutterstock
35	Origami House, Hawthorn, VIC Source: European Window Co.	45	Figure 35 Glass Suckers Source: Shutterstock
36	Sydney Rush Hour Source: Shutterstock	45	Figure 36 Glass Storage Racks Source: Shutterstock
37	Figure 30 Decibel Scale Source: Australian Fenestration Training Institute	46	Figure 37 PPE for Glass Handling Source: Work Cover NSW
38	Figure 31 Acoustic Performance of Float Glass Source: Australian Fenestration Training Institute	46	Figure 38 Glass Handling Procedures Source: Shutterstock (top), Viridian (bottom)
38	Figure 32 Acoustic Performance of Laminated Glass Source: Australian Fenestration Training Institute	47	Figure 39 Channel Glazing Source: Australian Glass and Window Association
38	Table 2 Acoustic Considerations for Dwellings Source: AS/NZS 2107	48	Figure 40 Wedge Glazing Source: Australian Glass and Window Association
39	Figure 33 Acoustic Double Glazing Source: Capral Aluminium	49	Figure 41 Wet Glazing Source: Australian Glass and Window Association
39	Figure 34 Acoustic Properties of Acoustic Laminate Glass Source: Australian Fenestration Training Institute	49	Figure 42 Butt-Joint Glazing Source: Australian Glass and Window Association
39	Table 3 Noise Reduction by Glass Type Source: Australian Glass and Window Association	50	Figure 43 Setting Blocks Source: Australian Glass and Window Association
40	Bushfire at Night Source: Shutterstock/Daniel Mitchell	52	Glass Sheet Exiting Processing Treatment Source: G.James
41	Table 4 Bushfire Attack Levels Source: AS 3959	53	Figure 44 Hand Cutting Glass Source: Shutterstock
42	Table 5 Bushfire Attack Level Requirements	53	Figure 45 Glass Cutting Tool Source: Shutterstock
		54	Figure 46 Glass Processing Machine: FOREL Vertical Edging Machine Source: Overseas Glass Agencies
		54	Table 6 Glass Edge Types and Applications Source: Australian Glass and Window Association
		55	Figure 47 Glass Processing Machine: CMS Futura P Glass Flat Wire Grinding Machine Source: SCM Group Australia
		55	Figure 48 Glass Processing Machine: CMS AGIL Glass Cutting Table Source: SCM Group Australia
		56	Figure 49 Glass Cutting Source: SCM Group Australia
		56	Figure 50 Glass Cutting Source: SCM Group Australia
		57	Figure 51 Edgework and Cut Outs in a Shower Screen Source: Viridian
		57	Figure 52 Glass Cut Outs Allow Affixed Hardware on an Internal Sliding Door Source: DLG Aluminium & Glazing
		58	Figure 53 Edge Condition: Feathering Source: AGWA
		58	Figure 54 Edge Condition: Shell Source: AGWA
		58	Figure 55 Scratches on Glass Source: AGWA
		58	Figure 56 Starts and Runs in Glass Source: AGWA
		58	Figure 57 How Runs Propagate Through Glass Under Stress Source: AGWA
		60	Figure 58 How Thermal Breakage Occurs in Glass Source: Australian Glass and Window Association
		60	Figure 59 Likelihood of Thermal Breakage as Compared with Glass Strength Source: Australian Glass and Window Association
		62	Australia Towers, Sydney Olympic Park, NSW

# AGWA GUIDE SERIES

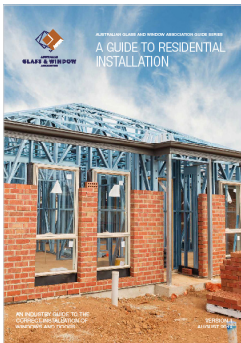
Window and Door Selection



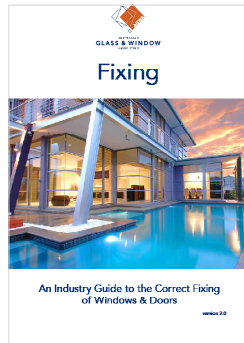
To download other guides in this series, visit [www.agwa.com.au](http://www.agwa.com.au)



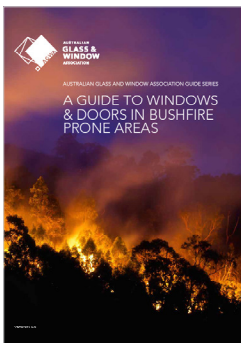
Installation



Fixing



Bushfire Areas



**a.** Suite 1, Level 1, Building 1, 20 Bridge Street, Pymble NSW 2073

**t.** +61 2 9498 2768

**f.** +61 2 9498 3816

**e.** [info@agwa.com.au](mailto:info@agwa.com.au)

**w.** [www.agwa.com.au](http://www.agwa.com.au)

Document No. AGWA2017/GGHBV3

Copyright © 2017 Australian Glass and Window Association.  
All Rights Reserved.

